



USA HOCKEY OFFICIAL RULES

**JUNIOR HOCKEY EDITION
2005-07 Seasons**

**Adopted June 11, 2005
Colorado Springs, Colorado**

The intent of this edition is to provide Junior "A", Junior "B", and those Junior "C" leagues given Junior Council approval with a rule book specific to the Junior program. Control of this document rests with the USA Hockey Board of Directors, in conjunction with the USA Hockey Playing Rules Committee.

TABLE OF CONTENTS

GENERAL INFORMATION

Philosophy of Junior Hockey	7
Points of Emphasis	9
Glossary	11
Official Signals	13

SECTION ONE

The Rink	17
----------------	----

SECTION TWO

Teams	23
-------------	----

SECTION THREE

Equipment	29
-----------------	----

SECTION FOUR

Penalties	37
-----------------	----

SECTION FIVE

Officials	47
-----------------	----

SECTION SIX

Playing Rules	53
---------------------	----

APPENDICES

Summary of Penalties	77
Summary of Face-Off Locations	81

ALPHABETICAL LISTING OF RULES

Abuse of Officials	Section 6	Rule 601	55
Adjustment to Clothing and Equipment	Section 6	Rule 602	57
Appointment of Officials	Section 5	Rule 501	49
Attempt to Injure	Section 6	Rule 603	57
Awarded Goals	Section 6	Rule 609	59
.....	Rule 612	61
.....	Rule 615	63
.....	Rule 636	72
.....	Rule 639	74
Bench Minor Penalties	Section 4	Rule 402	39
Board-Checking	Section 6	Rule 604	57
Broken Stick	Section 6	Rule 605	57
Butt-Ending	Section 6	Rule 608	58
Calling of Penalties	Section 4	Rule 409	44
Captain of Team	Section 2	Rule 202	25
Center Ice Spot and Circle	Section 1	Rule 106	20
Change of Players	Section 2	Rule 205	27
Charging	Section 6	Rule 606	58
Checking from Behind	Section 6	Rule 607	58
Clipping	Section 6	Rule 639	74
Composition of Teams	Section 2	Rule 201	25
Cross-Checking	Section 6	Rule 608	58
Dangerous Equipment	Section 3	Rule 305	35
Delayed Penalties	Section 4	Rule 408	43
Delaying the Game	Section 6	Rule 609	59
Deliberate Injury to Opponents	Section 6	Rule 603	57

Dimensions of Rink.....	Section 1	Rule 102	19
Division of Ice Surface	Section 1	Rule 105	20
Dressing Room Protocol.....	Section 1	Rule 113	22
Elbowing	Section 6	Rule 610	59
Electronic Equipment	Section 3	Rule 308	35
End Zone Face-Off Spots and Circles	Section 1	Rule 108	20
Equipment Measurement	Section 3	Rule 307	35
Facemasks	Section 3	Rules 303-304.....	32
Face-Offs	Section 6	Rule 611	60
Face-Off Spots in Neutral Zone	Section 1	Rule 107	20
Falling on Puck	Section 6	Rule 612	61
Fisticuffs	Section 6	Rule 613	61
Game Timekeeper.....	Section 5	Rule 507	52
Goal Crease/Goalkeeper Privileged Area	Section 1	Rule 104	19
Goal Judge	Section 5	Rule 504	51
Goalkeeper's Equipment.....	Section 3	Rule 303	32
Goalkeeper's Penalties	Section 4	Rule 407	43
Goal Posts and Nets.....	Section 1	Rule 103	19
Goals and Assists	Section 6	Rule 614	62
Gross Misconduct.....	Section 4	Rule 404	40
Gross Misconduct.....	Section 6	Rule 616	64
Handling Puck with Hands	Section 6	Rule 615	63
Head-Butting.....	Section 6	Rule 603	57
High Sticks	Section 6	Rule 617	64
Holding an Opponent	Section 6	Rule 618	64
Hooking.....	Section 6	Rule 619	64
Ice Cleaning	Section 6	Rules 635/637	71/73
Icing the Puck.....	Section 6	Rule 620	65
Illegal Puck	Section 6	Rule 630	70
Injured Players	Section 2	Rule 206	27
Interference.....	Section 6	Rule 621	65
Interference by Spectators	Section 6	Rule 622	66
Kicking Player	Section 6	Rule 623	67
Kicking Puck.....	Section 6	Rule 624	67
Kneeing	Section 6	Rule 610	59
Leaving Players' Bench or Penalty Bench	Section 6	Rule 625	67
Leg Checking	Section 6	Rule 639	74
Linesman.....	Section 5	Rule 503	50
Major Penalties	Section 4	Rule 403	40
Match Penalties	Section 4	Rule 405	41
Minor Penalties	Section 4	Rule 402	39
Misconduct Penalties	Section 4	Rule 404	40
Obscene Language or Gestures.....	Section 6	Rule 601	55
Official Scorer	Section 5	Rule 506	51
Official Signals			13
Off-Sides	Section 6	Rule 626	68
Passes.....	Section 6	Rule 627	69
Penalties	Section 4	Rule 401	39
Penalties - Automatic Expiry	Section 4	Rule 402	39
Penalty Bench.....	Section 1	Rule 110	21
Penalty Shot	Section 4	Rule 406	42
Penalty Timekeeper	Section 5	Rule 505	51
Players' Bench	Section 1	Rule 109	21
Players in Uniform.....	Section 2	Rule 203	25
Playing Line-up.....	Section 2	Rule 204	26
Preceding Puck into Attacking Zone	Section 6	Rule 626	68
Profane Language.....	Section 6	Rule 601	55
Proper Authorities	Section 5	Rule 508	52
Protective Equipment	Section 3	Rule 304	34
Puck	Section 3	Rule 306	35
Puck Must Be Kept in Motion	Section 6	Rule 629	70
Puck Out of Bounds or Unplayable	Section 6	Rule 628	69
Puck Out of Sight	Section 6	Rule 630	70

Puck Striking Official.....	Section 6	Rule 631	70
Referee	Section 5	Rule 502	49
Refusing to Start Play	Section 6	Rule 632	70
Rink	Section 1	Rule 101	19
Rink Diagram			3
Security Protection	Section 1	Rule 112	22
Signal and Timing Device	Section 1	Rule 111	21
Signals, Official			13
Skates	Section 3	Rule 302	31
Slashing	Section 6	Rule 633	71
Spearing	Section 6	Rule 634	71
Start of Game and Periods	Section 6	Rule 635	71
Starting Lineup	Section 2	Rule 204	26
Sticks	Section 3	Rule 301	31
Supplementary Discipline	Section 4	Rule 410	44
Throwing Stick	Section 6	Rule 636	72
Tied Games.....	Section 6	Rule 638	73
Time of Match.....	Section 6	Rule 637	73
Time-Outs	Section 6	Rule 637	73
Tripping	Section 6	Rule 639	74
Unnecessary Roughness	Section 6	Rule 640	74
Unsportsmanlike Conduct	Section 6	Rule 601	55

Rules changes are highlighted.

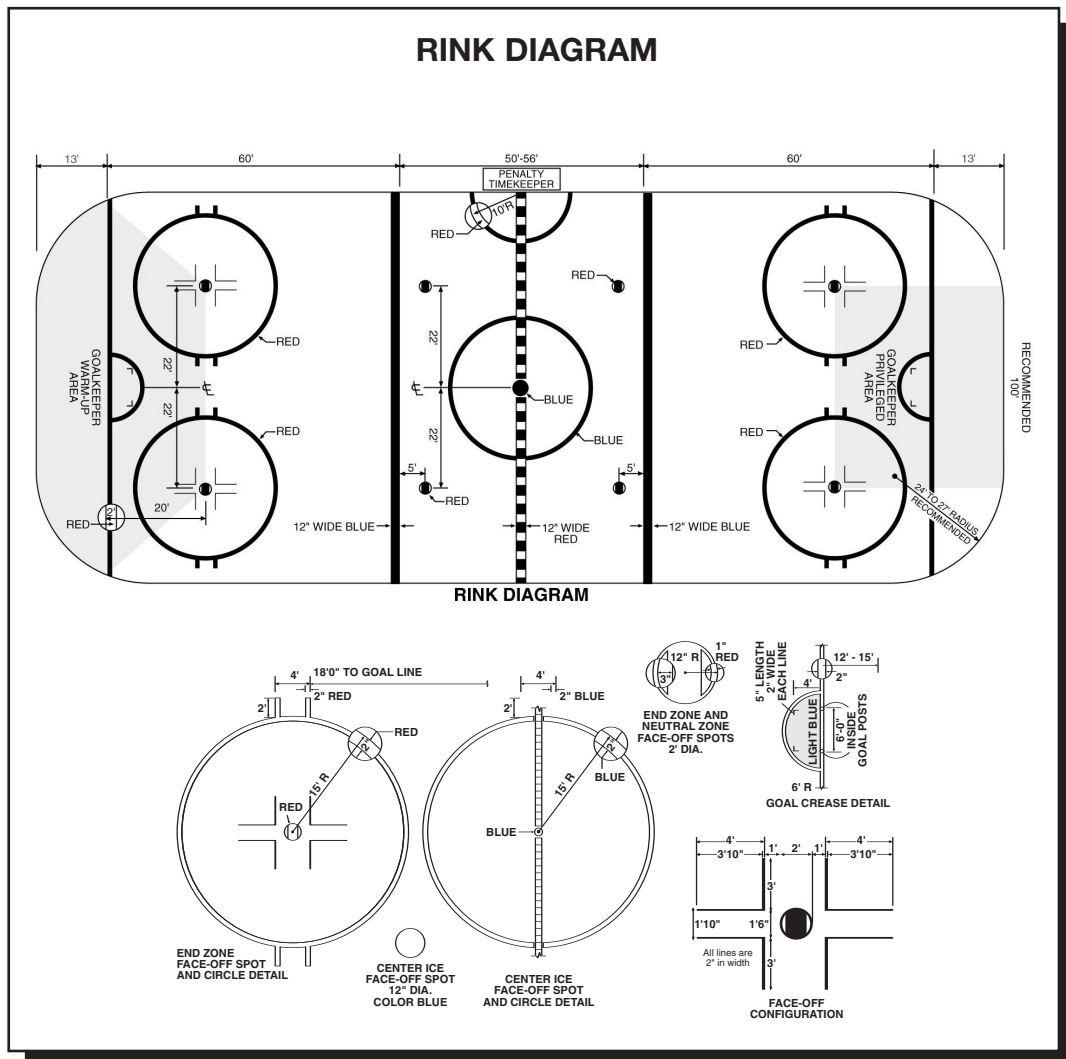



**GENERAL
INFORMATION**

PHILOSOPHY OF JUNIOR HOCKEY

WHAT IS JUNIOR HOCKEY?

Junior hockey is the pinnacle of the skill development program of USA Hockey. It is available to male athletes who are 20 & under as of the 31st day of December in the season of competition.

The program is available to high school students and graduates who seek a greater or different challenge than that which might be available through their prep school team, high school varsity or club team, or area midget teams. The principal purpose of this development program is to prepare the athlete for career advancement either in a collegiate or professional opportunity.

WHAT IS THE PURPOSE OF JUNIOR HOCKEY?

The purpose of Junior hockey is really two-fold:

1. To provide an opportunity for players in this age group to play organized hockey; and
2. To improve and develop the skills and abilities of the participants, including the players, coaches, and officials.

WHAT ARE THE GOALS OF JUNIOR HOCKEY?

1. Skill Development

To provide talented young men with the opportunity to develop competitively in an organized, structured, and supervised environment;

2. Quality Coaching

To provide considerable training time, quality coaching, and concerned supervision;

3. Social Maturity

To provide players with a healthy, constructive environment in which to develop socially;

4. Educational Advancement

To provide assistance and opportunities for the accomplishment of the participant's educational goals;

5. Recruiting Exposure

To provide players with exposure to collegiate and professional scouts and recruiters;

6. Advanced Competition

To provide players with exposure to national and international competition;

7. Protection of Amateur Status

To protect, most importantly, the amateur status of all participants under the rules and guidelines established by the International Ice Hockey Federation, USA Hockey, Hockey Canada, the NCAA, the NAIA, and the National Federation of High Schools.

POINTS OF EMPHASIS

CHECKING FROM BEHIND

One of the most serious rule infractions in our sport is checking from behind. There is never an excuse for a player to check another player from behind. Officials are instructed to call every checking from behind infraction that occurs. If the check from behind occurs in the area two feet from the boards or in open ice, the officials have the choice of assessing a minor, minor plus misconduct, double minor plus game ejection, or a major plus game misconduct penalty. Should the check from behind be delivered in the area two feet to eight feet from the boards or into the goal, the officials shall have no alternative but to assess a minor plus misconduct, double minor plus game ejection, or a major plus game misconduct penalty. This infraction may also be treated as attempt to injure or deliberate injury of an opponent.

Officials are instructed to beware of players who turn their backs on a check. However, the onus of a check being delivered is still with the player delivering the check. **This infraction is not a discussion point. Any coach/player who protests a check from behind may be assessed a bench minor/misconduct penalty.**

VERBAL ABUSE

Any team official who shouts at or makes **any** comments towards an opposing player or team official, whether on the ice or on the bench, will be assessed a **game misconduct penalty**. No warning. The penalty for a player on his player's bench or penalty bench who shouts at an opposing player on the ice is a misconduct penalty. A player who is on the ice and makes a derogatory comment to an opposing player off the ice shall be assessed a misconduct penalty. A player who makes a derogatory comment to any opposing team official shall be assessed a game misconduct penalty. Any derogatory hand gesture (waving, clapping, etc.) by a team member shall be penalized. Officials will never, under any circumstances, make any unprofessional comments or gestures toward a team official, player or fan.

STICK INFRACTIONS

High sticking should always be treated the same, regardless of whether or not a player has facial protection. A small cut is not necessarily considered an injury. Officials are instructed to call a double minor penalty if injury occurs from an accidental high stick, or a major plus game ejection/game misconduct penalty if the injury was caused by a careless high stick. Spearing and butt-ending should also be called the same. If a player attempts to spear or butt-end an opponent the officials should assess a minor plus misconduct penalty. If the player makes contact with his opponent the proper call should be a double minor plus game ejection or a major plus a game misconduct penalty. Intent and delivery of the spear or butt-end should determine the correct application of this rule. These infractions may also be treated as attempt to injure or deliberate injury of an opponent.

Slashing will be called anytime the following occurs:

1. Any intimidating slashing or chopping motion to an opponent (regardless of what part of the body the stick contact is made).
2. Slashing or chopping an opponent that occurs above the waist, including the arm and hand area.
3. Slashing or chopping motions to an opponent where the aggressor's hands are less than 18 inches apart.

These infractions are not a discussion point. Any coach/player who protests a stick infraction penalty may be assessed a bench minor/misconduct penalty.

INTERFERENCE

This illegal tactic is increasing in our game and needs stricter enforcement. Officials must be aware of the following types of interference:

1. Forecheckers setting picks – interference penalty
2. Backcheckers tying up opponents by hooking while not keeping their feet moving, particularly in the neutral zone – hooking/interference penalty
3. Face-off interference – holding/interference penalty
4. Holding/grabbing the stick – holding/interference penalty
5. Holding/grabbing the jersey – holding/interference penalty

GOALTENDER INTERFERENCE

The goaltender is never fair game and all players have a responsibility to avoid all contact with the opposing goaltender. Officials shall always be aware of any goaltender that places himself into the unavoidable position of being contacted by an opponent. Officials are instructed to point out to the goaltender any teammate who pushes an opposing player into or on top of their own goalkeeper. Officials are reminded to apply the “crease” rule when appropriate.

UNNECESSARY CONTACT DURING TOUCH-ICING

All officials are to make this the number one priority this season. Even a very soft push during a touch-icing situation is not acceptable. This infraction may also be treated as attempt to injure or deliberate injury of an opponent. **This policy is not open to discussion or interpretation. Any coach/player who protests a penalty call on a touch-icing situation maybe assessed a bench minor/misconduct penalty.**

HEAD CONTACT

Deliberate contact above the shoulders of an opponent is a violation of the rules and must be penalized. Officials are directed to strictly enforce and penalize all deliberate or aggressive contact made with an opponent above the shoulder using the forearm, fist, shoulder, stick or knee. Although the “head contact” rule has been removed from the rulebook, these infractions must be assessed using the roughing, elbowing or kneeing, or the high sticking playing rules.

GLOSSARY

Aggressor: A player is deemed the aggressor when he has clearly won the fight but he continues throwing and landing punches in a further attempt to inflict punishment and/or injury on his opponent who is no longer in a position to defend himself.

Altercation: Any physical interaction between two or more opposing players resulting in a penalty or penalties being assessed.

Body Checking: A legal body check is one in which a player checks an opponent who is in possession of the puck, by using his hip or body from the front, diagonally from the front or straight from the side, and does not take more than two fast steps in executing the check.

Legitimate body checking must be done only with the trunk of the body (hips and shoulders) and must be above the opponent's knees and below the neck. If body checking is unnecessarily rough, it must be penalized.

Body Contact: Contact that occurs between opponents during the normal process of playing the puck, provided there has been no overt hip, shoulder or arm contact to physically force the opponent off of the puck.

Break-away: A condition whereby a player is in control of the puck with no opposition between the player and the opposing goal, with a reasonable scoring opportunity.

Butt-Ending: The condition whereby a player uses the shaft of the stick above the upper hand to jab or attempt to jab an opposing player.

Coach: A coach is a person primarily responsible for directing and guiding the play of his team. Along with the Manager, he is responsible for the conduct of his team's players before, during and after a game.

Coincident Penalty: A penalty of equal type (e.g., minor or major) assessed during the same stoppage of play, and for which neither team is reduced in on-ice numerical strength. A coincident penalty never causes either team to be "shorthanded" for purposes of penalty termination if a goal is scored.

Creases: *Goalkeeper's* - Areas marked on the ice in front of each goal designed to protect the goalkeepers from interference by attacking players. *Referee's* - Area marked on the ice in front of the penalty timekeeper's seat for the use of the referee.

Cross-Checking: When a player, holding his stick with both hands, checks an opponent by using the shaft of the stick with no part of the stick on the ice.

Delayed Off-Side: A situation where an attacking player has preceded the puck across the attacking blue line, but the defending team has gained possession of the puck and is in a position to bring the puck out of their defending zone without any delay or contact with an attacking player.

Deflecting the Puck: The action of the puck contacting any person or object, causing it to change direction.

Directing the Puck: The act of intentionally moving or positioning the body, skate or stick so as to change the course of the puck in a desired direction.

Face-Off: The action of an official dropping the puck between the sticks of two opposing players to start play. A face-off begins when the referee indicates its location and the officials take their appropriate positions, and ends when the puck has been legally dropped.

Fisticuffs: The actual throwing of a punch (closed fist) by a player which makes contact with an opponent.

Game Suspension(s): When a player, coach or manager receives a game suspension(s), he shall not be eligible to participate in the next game(s) that were already on the schedule of that team before the incident occurs.

Goalkeeper: A goalkeeper is a person designated as such by a team who is permitted special equipment and privileges to prevent the puck from entering the goal.

Head-Butting: The physical use of one's head in the course of delivering a body-check (head first) in the chest, head, neck or back area or the physical use of the head to strike an opponent.

Head Contact: The action of a player intentionally or recklessly contacting a player in the head, including with the stick or by an illegal body check (as defined in this glossary). Although the "head contact" rule has been removed from the rulebook, these infractions must be assessed using the roughing, elbowing or kneeing, or the high sticking playing rules.

HECC: The Hockey Equipment Certification Council is an independent organization responsible for the development, evaluation and testing of performance standards for protective ice hockey equipment. To date, there are standards for facemasks, helmets and skate blades.

Heel of the Stick: The point where the shaft of the stick and the bottom of the blade meet.

Hooking: The action of applying the blade of the stick to any part of an opponent's body or stick and impeding his progress by a pulling or tugging motion with the stick.

Injury Potential Penalties: Injury potential penalties include butt-ending, checking from behind, head-butting, spearing, board checking, charging, cross checking, elbowing/kneeing, high sticking, holding the facemask, slashing and roughing. The linesman may report such infractions to the referee, following the next stoppage of play, that have occurred behind the play and were unobserved by the referee.

Last Play Face-Off: The location at which the puck was last legally played by a player or goalkeeper immediately prior to a stoppage of play.

Off-Ice (Minor) Official: Officials appointed to assist in the conduct of the game including the official scorer, game timekeeper, penalty timekeeper and the two goal judges. The referee has general supervision of the game and full control of all game officials, and in case of any dispute the referee's decision shall be final.

Penalty: A penalty is the result of an infraction of the rules by a player or team official. It usually involves the removal from the game of the offending player or team official for a specified period of time. In some cases the penalty may be the awarding of a penalty shot on goal or the actual awarding of a goal.

Player: Member of a team physically participating in a game. The goalkeeper is considered a player except where special rules specify otherwise.

Possession of the Puck: The last player or goalkeeper to make contact with the puck. This includes a puck that is deflected off a player or any part of his equipment.

Possession and Control of the Puck: The last player or goalkeeper to make contact with the puck and who is also propelling the puck in a desired direction.

Proper Authorities (Proper Disciplinary Authority): The immediate governing body of the team or teams involved, except:

- (1) In USA Hockey tournaments and play-offs, the body shall be the Discipline Committee of the tournament or play-off.
- (2) For Junior league play, this shall be the Junior Council sanctioned league.

Protective Equipment: Equipment worn by players for the sole purpose of protection from injury. Recommended equipment should be commercially manufactured.

Shorthanded: Shorthanded means that a team is below the numerical strength of its opponents on the ice. When a goal is scored against a shorthanded team, the minor or bench minor penalty which terminates automatically is the first such non-coincident penalty (the minor or bench minor penalty then being served with the least amount of time remaining). Thus, if an equal number of players from each team is serving a penalty(s) (minor, bench minor, major or match only), neither team is "shorthanded."

Slashing: The action of striking or attempting to strike an opponent with a stick or of swinging a stick at an opponent with no contact being made. Tapping an opponent's stick is not considered slashing.

Spearing: The action of poking or attempting to poke an opponent with the tip of the blade of the stick while holding the stick with one or both hands.

Substitute Goalkeeper: A designated goalkeeper on the official scoresheet who is not then participating in the game.

Team Official: A person responsible in any degree for the operation of a team, such as a team executive, coach, manager or trainer.

Temporary Goalkeeper: A player not designated as a goalkeeper on the official scoresheet who assumes that position when no designated goalkeeper is able to participate in the game. He is governed by goalkeeper privileges and limitations, and must return as a "player" when a designated goalkeeper becomes available to participate in the game.

OFFICIAL SIGNALS

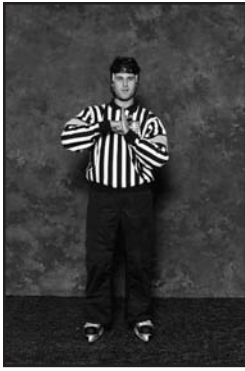

Boarding

Striking the closed fist of the hand once into the open palm of the other hand.



Butt-Ending

Moving the forearm, fist closed, under the forearm of the other hand held palm down.



Charging

Rotating clenched fists around one another in front of chest.



Checking from Behind

A forward motion with both hands, palms open, extending from the chest.

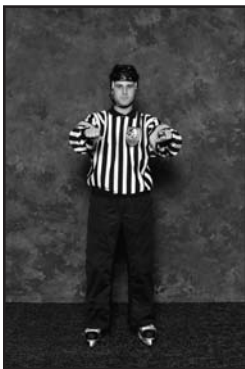

Cross-Checking

A forward motion with both fists clenched extending from the chest.



Delayed Calling of Penalty

The non-whistle hand is extended straight above the head.



Delaying the Game

The non-whistle hand, palm open, is placed across the chest and then fully extended directly in front of the body.



Elbowing

Tapping the elbow with the opposite hand.

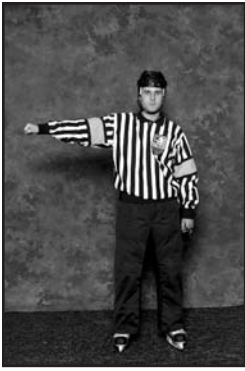

Fighting (Roughing)
Once punching motion to the side with the arm extending from the shoulder.



Goal Scored
A single point, with the non-whistle hand, directly at the goal in which the puck legally entered.

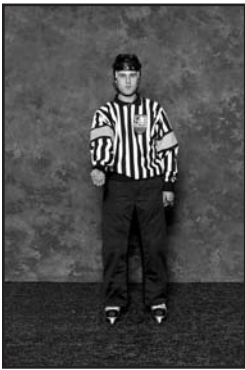

Hand Pass
The non-whistle hand (open hand) and arm are placed straight down alongside the body and swung forward and up once in an underhand motion.



High-Sticking
Holding both fists, clenched, one immediately above the other, at the side of the head.



Holding
Clasping the wrist of the whistle hand well in front of the chest.



Holding the Facemask
Closed fist held in front of face, palm in, and pulled down in one straight motion.

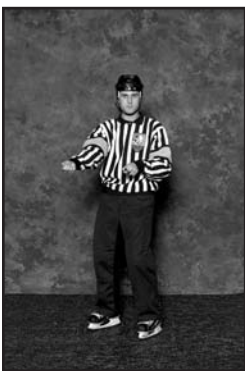

Hooking
A tugging motion with both arms, as if pulling something toward the stomach.



Icing
When the puck is shot or deflected in such a manner as to produce a possible icing situation, the back linesman will signal to his partner by raising the non-whistle hand over his head (same as Slow Whistle). The instant that the conditions required to establish "icing the puck" have occurred, the front linesman will blow his whistle to stop play and raise his non-whistle hand (same as Slow Whistle). The back linesman will give the icing signal by folding his arms across the chest.



Interference

Crossed arms stationary in front of chest with fists closed.



Kneeing

A single tap of the right knee with the right hand, keeping both skates on the ice.



Match Penalty

Pat flat of hand on the top of the head.



Misconduct

Placing of both hands on hips one time.



Penalty Shot

Arms crossed (fists clenched) above head.

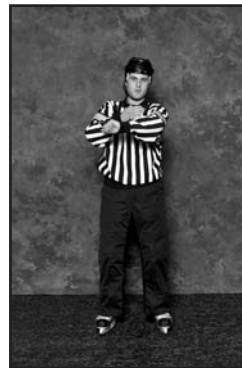

Slashing

One chop of the hand across the straightened forearm of the other hand.



Delayed (Slow) Whistle

(Blue-Line Off-Sides) The non-whistle hand is extended straight above head. If play returns to Neutral Zone without stoppage, the arm is drawn down the instant the puck crosses the line, or as soon as the offending team clears the zone.



Spearing

A single jabbing motion with both hands together, thrust forward from in front of the chest, then dropping hands to the side.

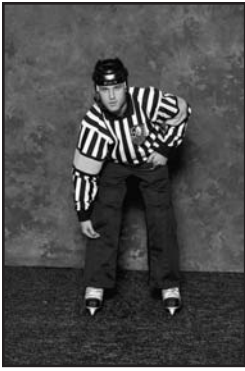

Tripping

Strike the side of the knee and follow through once, keeping the head up and both skates on the ice.



Time-Out and Unsportsmanlike Conduct

Use both hands to form a "T".



"Wash-Out"

Both arms are swung laterally across the body at shoulder level with palms down.

1. When used by the Referee, it means no goal or violation so play shall continue.
2. When used by Linesmen, it means there is no icing, off-side, or high-sticking violation.



SECTION ONE THE RINK

NOTE:

Within this text, the words "he", "him" and "his" are used to include both male and female participants.

Rule 101. Rink

- (a) The game of “Ice Hockey” shall be played on an ice surface known as a “RINK”.

Rule 102. Dimensions of Rink

- (a) As nearly as possible, the dimensions of the rink shall be 200 feet long and 100 feet wide. In all ice rinks used for invitational tournaments and regional Playoffs and national championships the ice surface dimensions shall be not less than 185 feet by 85 feet.

The rink shall be surrounded by a wooden or fiberglass wall or fence, known as the “BOARDS”, which shall extend not less than 40 inches and not more than 48 inches above the level of the ice surface. The ideal height of the boards above the ice surface shall be 42 inches. It is recommended that the kickplate at the bottom of the boards be yellow.

The corners shall be uniformly rounded in the arc of a circle with a radius of 23 feet minimum to 28 feet maximum.

(Note) USA Hockey recommends that for new or refurbished construction refer to the ASTM Standard Guide for Ice Hockey Playing Facilities (F1703-04).

- (b) The boards shall be constructed in such a manner that the surface facing the ice shall be smooth and free of any obstruction or any object that could cause injury to players.

All doors giving access to the playing surface must swing away from the ice surface.

It is recommended that the entire rink, including players and penalty benches, be enclosed by protective safety glass, wire and/or other protective screens of sufficient height designed to separate players from spectators. All gear used to hold such protective equipment in place shall be mounted on the boards on the side away from the playing surface.

- (c) It is strongly recommended that enhanced spectator netting be installed in the ends and corners of the arena.

Rule 103. Goal Posts and Nets

- (a) A minimum of 12 feet from each end of the rink and in the center of a red line two inches wide drawn completely across the width of the ice and continuing vertically up the side of the boards, regulation goal posts and nets shall be set in such a manner as to remain stationary during the progress of a game. The goal posts may be kept in position by metal rods, pipes or similar means affixed in the ice or floor. If anchoring of the goal posts is applicable, they shall be anchored in such a manner as to permit a goal post to be dislodged when hit by a degree of force such as would be provided by a player sliding into or being checked into it. It is recommended for all games, and required for all National Tournament games, that flexible peg type goal anchors be utilized.

If the distance from the end of the rink to the goal line is not 12 feet, it must be a minimum of 12 feet and a maximum of 15 feet.

- (b) The goal posts shall be of approved design and material, extending vertically four feet above the surface of the ice and set six feet apart measured from the inside of the posts. A cross bar of the same material as the goal posts shall extend from the top of one post to the top of the other. It is recommended that the goal frames do not have a metal deflector plate along the base of the back of the goal frame.
- (c) There shall be attached to each goal frame a net of approved design.
- (d) The goal posts and cross bars shall be painted in red and all other exterior surfaces shall be painted in white.
- (e) The red line, two inches wide, between the goal posts on the ice and extended completely across the rink, shall be known as the “GOAL LINE”.
- (f) The Goal area, enclosed by the goal line and the base of the goal, shall be painted white.

Rule 104. Goal Crease and Goalkeeper’s Privileged Area

- (a) In front of each goal a “GOAL CREASE” area shall be marked by a red line two inches in width.
- (b) The goal crease shall be laid out as follows: A semi-circle six feet in radius and two inches in width shall be drawn using the center of the goal line as the center point. The goal crease area, excluding the red lines, shall be painted light blue in color. It is recommended that there shall be two “L-shaped” red markings in each goal

crease. Each line shall be five inches long and two inches wide. The corners shall touch the goal crease line four feet out from the goal line. The lines shall be both parallel and perpendicular to the goal line.

- (c) The goal crease area shall include all the space outlined by the semi-circular crease lines (including crease lines) and extending vertically to the level of the top of the goal frame.
- (d) The goalkeeper's "PRIVILEGED AREA" is an area bounded in the rear by the end boards, in front by an imaginary line connecting the end zone face-off spots and on the sides by imaginary lines extending perpendicular from the end boards to the end zone face-off spots. (For the goalkeeper's privileges within this area, see Rules 606(b) Note, Charging, and 612(b), Falling on Puck.)
- (e) The goalkeepers may only take warm-ups in the Goalkeeper's Privileged Area extended to include the area formed by a line from each end zone face-off spot to where the goal line meets the side boards. (See Rink diagram.)

For a violation of this rule, after a warning, the offending team shall be assessed a bench minor penalty.

Rule 105. Division of Ice Surface

- (a) The ice area between the two goals shall be divided into three parts by lines, 12 inches in width, and blue in color, drawn 60 feet out from the goal lines, and extended completely across the rink, parallel with the goal lines and continued vertically up the side of the boards. The 60 feet shall be measured from the edge of the goal line closest to the end boards to the furthest edge of the blue line.
- (b) That portion of the ice surface in which the goal is situated shall be called the "DEFENDING ZONE" of the team defending that goal; the central portion shall be known as the "NEUTRAL ZONE" and the portion farthest from the defended goal as the "ATTACKING ZONE". The zone line shall be considered part of the zone that the puck is in.
- (c) There shall also be a line, 12 inches in width, and red in color, drawn completely across the rink in center ice, parallel with the goal lines and continued vertically up the side of the boards, known as the "CENTER LINE". This line shall contain at regular intervals markings of a uniform and distinctive design which will easily distinguish it from the two blue lines, the outer edges of which must be continuous.
- (d) There shall be no markings on the ice except as provided under these rules without the expressed written permission of the League. On-ice logos and advertised marks must not interfere with any official game markings, and must conform to League policy.

For violation of this rule, the league shall give written notice to conform. Failure to conform within 10 days of said notice may result in a team fine not to exceed two hundred dollars (\$200) per game in violation.

Rule 106. Center Ice Spot and Circle

- (a) A circular blue spot, 12 inches in diameter, shall be marked exactly in the center of the rink; and with this spot as a center, a circle of 15 feet radius shall be marked with a blue line two inches in width. The width of this line shall be included in the radius.

Rule 107. Face-off Spots in Neutral Zone

- (a) Two red spots two feet in diameter shall be marked on the ice in the Neutral Zone five feet from the near edge of the blue line. Within each face-off spot draw two parallel lines four inches from the top and bottom of the spot. The area within the two lines shall be painted red, the remainder shall be painted white. The spots shall each be 22 feet from the center of the ice surface.

Rule 108. End Zone Face-off Spots and Circles

- (a) In both end zones and on both sides of each goal, red face-off spots and circles shall be marked on the ice. The face-off spots shall be two feet in diameter. Within each face-off spot draw two parallel lines four inches from the top and bottom of the spot. The area within the two lines shall be painted red, the remainder shall be painted white.

One foot away from the outer edges of the face-off spot, two lines shall be drawn parallel with the side boards that shall be four feet in length and eighteen inches apart. Parallel to the end boards, commencing at the end of the line nearest to the face-off spot, a line shall extend two feet ten inches in length. All lines shall be two inches in width.

The circles shall be two inches wide with a radius of fifteen feet from the center of the face-off spots. The width of this line shall be included in the radius. On both sides of each end zone face-off circle shall be two lines two feet long, two inches wide and four feet apart.

- (b) The location of the face-off spots shall be fixed in the following manner: Along a line 20 feet from each goal line and parallel to it, mark two points 22 feet on both sides of the straight line joining the centers of the two goals. Each such point shall be the center of a face-off spot and circle.

Rule 109. Players' Bench

- (a) Each rink shall be provided with seats or benches for the use of players of both teams and the accommodations provided including benches and doors shall be uniform for both teams. Such seats or benches shall have accommodations for at least 14 persons of each team, and shall be placed immediately alongside the ice, in the Neutral Zone, as near to the center of the rink as possible with doors opening in the Neutral Zone and convenient to the dressing rooms.

Each players' bench should be 24 feet in length. The players' benches should be on the same side of the playing surface opposite the penalty bench and should be separated by a substantial distance. Where physically possible, each players' bench shall have two doors in the Neutral Zone and all doors opening to the playing surface shall be constructed so that they swing away from the surface.

- (b) None but players in uniform, and Team Officials (up to a maximum of four) shall be permitted to occupy the bench area so provided. Non-playing personnel under the age of majority shall wear a HECC-approved hockey helmet and facemask at all time while on the team bench.
- (c) There shall be no use of tobacco products or alcoholic beverages on the players' bench, penalty bench, timekeeping area or on the ice by any person. A team shall be warned by the Referee for the first offense by any player or Team Official during a game and, thereafter, a bench minor penalty shall be assessed for each such offense during the game.

Rule 110. Penalty Bench

- (a) Each rink must be provided with benches or seats to be known as the "PENALTY BENCH." It is preferable to have separate penalty benches for each team to be separated from each other and substantially separated from either players' bench. The penalty bench(es) must be situated in the Neutral Zone.

Nonpenalized players and goalkeepers are not permitted to occupy the penalty bench. For a violation of this rule, play shall not continue until the offending player(s) have been removed.

- (b) On the ice immediately in front of the Penalty Timekeeper's seat there shall be marked in red on the ice a semicircle of ten feet radius and two inches in width which shall be known as the "REFEREE'S CREASE."

Rule 111. Signal and Timing Devices

- (a) Each rink shall be provided with a siren, or other suitable sound device, for the use of Timekeepers.
- (b) Each rink shall be provided with some form of electrical clock for the purpose of keeping the spectators, players and game officials accurately informed as to all time elements at all stages of the game, including the time remaining to be played in any period.

Time recording for both game time and penalty time shall show time remaining to be played or served.

- (c) Behind each goal electric lights shall be set up for the use of the Goal Judges. A red light will signal the scoring of a goal. Where automatic lights are available, a green light will signify the end of a period or a game. All arenas must be equipped with an operational red/green automatic lighting system. Failure to do so may result in a team fine of up to two hundred dollars (\$200) per game.

(Note) A goal cannot be scored when a green light is showing.

The red light shall be connected to the timing device in such a manner so that when the period ends it will not be possible for the Goal Judge to turn it on. However, the fact that the Goal Judge may not be able to turn on the red light does not necessarily mean that no goal has been scored. The determining factor is whether or not the puck completely crosses the entire goal line before the period ends.

Rule 112. Security Protection

- (a) All home teams shall provide adequate police or other protection for all players and officials at all times. The Referee shall report to the League President any failure to provide adequate protection observed or reported with the particulars of such failure. Teams failing to provide adequate police or other protection may be subject to a fine up to two thousand dollars (\$2,000).
- (b) The Home Team shall provide, prior to the start of the game, information to the visiting team regarding a secure area for non-dressed and suspended players.

Rule 113. Dressing Room Protocol

- (a) Home Teams shall provide to the visiting team an adequate dressing room not less than two hours prior to the scheduled start of the game. The dressing room facilities must be able to be locked and include good lighting and shower facilities.
- (b) Home Teams shall provide to the On-Ice Officials an adequate dressing room not less than two hours prior to the scheduled start of the game. The dressing room facilities must be able to be locked and include good lighting and shower facilities.

Failure to do so will result in the home team being unable to use their dressing room until the visitors' room is available.



SECTION TWO
TEAMS

Rule 201. Composition of Teams

- (a) A team must start a game with six players on the ice. Any time that a team has been reduced to less than four players, the game shall be declared a forfeit. A maximum of 18 players, plus not more than two goalkeepers, shall be permitted to play in a game. For pre-season/exhibition games, a maximum of 20 players plus two goalkeepers shall be permitted to play in a game.
- (b) Each team shall appoint and designate on the scoresheet a Head Coach and an Assistant Coach prior to the start of the game. The Head Coach and Assistant Coach shall be in control of and responsible for the actions of all team personnel. All teams shall register with the USA Hockey Junior Registrar and forward to the League the names of their Head Coach, and any Assistant Coaches. Failure to comply may result in a fine of up to one thousand dollars (\$1,000) per occurrence per game.

Rule 202. Captain of Team

- (a) One Captain, and not more than two Alternates, shall be appointed by each team, and they shall have the privilege of discussing with the Referee any questions relating to interpretation of rules which may arise during the progress of a game. They should wear the letter “C” or “A”, approximately three inches in height and in contrasting color, in a conspicuous position on the front of his sweater.

Should a team have more than one player wearing a “C” and/or more than two players wearing “A’s,” the team shall lose its privilege of discussing any situation or interpretations with the game officials. Additionally, after a warning by the League, the team may be subject to a fine not to exceed twenty five dollars (\$25) for each game in violation.

- (b) The Referee and Official Scorer shall be advised prior to the start of each game, the name of the Captain of the team and the designated Alternate(s). This information will be added to the scoresheet.
- (c) No goalkeepers shall be entitled to exercise the privileges of Captain.
- (d) Any Captain or player who comes off the bench and makes any protest or intervention with the Officials for any purpose shall be assessed a minor penalty under Rule 601(a), Abuse of Officials.

A complaint about a penalty is NOT a matter “relating to the interpretation of the rules” and a minor penalty shall be imposed against any Captain or other player making such a complaint.

Rule 203. Players in Uniform

- (a) At the beginning of each game the Manager or Coach of each team shall list the players and goalkeepers who shall be eligible to play in the game. This list shall be given to the Referee or Official Scorer, and no change shall be permitted in the list or addition thereto shall be permitted after commencement of the game.
- (b) Each team shall be allowed one goalkeeper on the ice at one time. The goalkeeper may be removed and another player substituted. Such substitute shall not be permitted the privileges of the goalkeeper. A goalkeeper may be substituted for by another goalkeeper during play with full goalkeeper privileges. However, once a goalkeeper has been replaced by a substitute goalkeeper, he may not return to play until the next stoppage of play. For a violation, a bench minor penalty shall be assessed for illegal substitution.
- (c) Each player and each goalkeeper listed in the lineup of each team shall wear a visible individually identifying number at least ten inches high on the back of his sweater. Sweater numbers must be whole numbers between 1 and 99 inclusive. In addition, each player and goalkeeper shall wear numbers at least three inches high on both of his sleeves. Additionally, each player and goalkeeper shall wear his surname in full, in block letters three inches high, across the back of his sweater at shoulder height. All promotional/warm-up jerseys must be numbered. No sweater shall be altered so a player may gain an unfair advantage during an altercation.

All players of each team shall be dressed uniformly with approved design and color of their helmets, sweaters, pants, stockings and skates. Additionally, unless previously agreed to, the home team shall wear “light” colors while the visiting team shall wear “dark” colors.

Failure to do so may result in a fine of up to fifty dollars (\$50) per occurrence, per player per game.

- (d) It is required that each team have on its bench a substitute goalkeeper who shall be fully dressed and equipped to play.

When the substitute goalkeeper enters the game he will take his position without delay and no warm-up shall be permitted, except when either team uses its Time-out under Rule 637(e).

- (e) Except when the goalkeeper(s) is/are incapacitated, no player on the playing roster in that game shall be permitted to wear the equipment of the goalkeeper. If a team's goalkeeper(s) is unavailable to continue a team must immediately appoint a temporary goalkeeper (see Glossary) or place an additional skater on the ice with none of the goalkeeper's privileges.
- (f) All teams must dress a minimum of 11 competitors (one goalkeeper and 10 skaters) for all games. The only allowable exceptions to this rule are for weather problems, team sickness, and/or suspensions. Any violations of this rule are to be brought to the attention of the Discipline Committee by the opposing Team Officials and the Referee. Suspensions and/or fines may result from an infraction of this rule.
- (g) Should a skating player be suspended because of a game misconduct penalty with less than five minutes remaining in regulation play or anytime during overtime, his spot may not be filled on the game roster by another player. The team must play the next scheduled game with a "short" roster. If a goalkeeper is suspended, his spot on the roster may be filled by another goalkeeper.
- (h) Each member club should dress two goalkeepers for each League game. However, in the event of injury or sickness to one of the goalkeepers and no additional goalkeeper is on the Protected List or Active Roster, the League will institute emergency procedures to assure that a back-up goalkeeper is furnished for a League game. The emergency procedure may involve the use of the opposing team's back-up goalkeeper during the game if an injury occurs to a goalkeeper who is playing in a game and a member club does not have a back-up dressed. The member club with the injured or sick goalkeeper shall have five days to add another goalkeeper to the Protected List to give them a minimum of two goalkeepers who are fit for play. The emergency replacement goaltender may not play in a game unless the remaining goaltender is unable to participate due to disability or suspension. The application for permission to use an emergency goaltender shall be first submitted to the team's league commissioner and subject to USA Hockey approval. Violations of this rule shall be reported to the USA Hockey Junior Registrar and the League office following the completion of the game.
- (i) Only League authorized logo/marks may be displayed on the players' uniforms and/or equipment. Any player or goalkeeper not complying with this rule shall be ordered off the ice surface by the Referee at the first stoppage of play, and shall not be permitted to return until he complies with the rule. Any unauthorized logo/mark must be covered to be considered in compliance. Should the player return to the ice and not be in compliance, he shall be assessed a game ejection penalty.

Rule 204. Playing Lineup

- (a) Upon the Referee's signal prior to the start of a period and following any stoppage of play, the visiting team shall promptly place a lineup on the ice, ready for play and no substitution shall be made from that time until play has been resumed. The home team may then make any desired substitution which does not result in the delay of the game.

If there is any undue delay by either team in changing lines, the Referee shall order the offending team or teams to take their positions immediately and not permit line changes.

(Note) When a substitution has been made under the above rule, no additional substitution may be made until play commences except when any penalty is imposed .

- (b) Prior to the start of the game, at the request of the Referee, the Manager or Coach of the visiting team is required to name a starting lineup to the Referee or the Official Scorer.
- (c) Prior to the start of the game, the Manager or Coach of the home team, having been advised by the Official Scorer or the Referee of the names of the starting lineup of the visiting team, shall name the starting lineup of the home team which information shall be conveyed by the Official Scorer or the Referee to the Coach of the visiting team.
- (d) No change in the starting lineup of either team as given to the Referee or Official Scorer, or in the playing lineup on the ice, shall be made until the game is actually in progress, unless a penalty which affects the on-ice strength of either team is assessed prior to the start of the game. For an infraction of this rule a bench minor penalty shall be imposed upon the offending team, provided such infraction is called to the attention of the Referee by the opposing team Captain before the second face-off in the first period takes place.

Rule 205. Change of Players

- (a) Players may be changed at any time from the players' bench, provided that the player or players leaving the ice shall always be at the players' bench and out of the play before any change is made.

If, in the course of making a substitution, either the player entering or leaving the game deliberately plays the puck with the stick, skates or hands or checks or makes any physical contact with an opposing player while the retiring player is actually on the ice, then a bench minor penalty for "too many players on the ice" will be called.

(Note) If, in the course of a substitution, either the player entering the play or the player retiring is struck by the puck accidentally, the play will not be stopped and no penalty will be called.

- (b) A goalkeeper may be changed for another player at any time under the conditions set out in this section.

(Note) When a goalkeeper leaves his goal area and proceeds to his players' bench for the purpose of substituting another player, the rear Linesman shall be responsible to see that the substitution made is not illegal by reason of the premature departure of the substitute from the bench (before the goalkeeper is within ten feet of the bench). If the substitution is made prematurely, the Linesman shall stop the play immediately by blowing his whistle unless the non-offending team has possession of the puck, in which event the stoppage will be delayed until the puck changes hands. There shall be no time penalty to the team making the premature substitution but the resulting face-off will take place on the center face-off spot. Where play has stopped with the puck in the offending team's defending half of the ice, the face-off shall take place at the point of the stoppage of play, unless otherwise covered in these rules.

- (c) If there are less than two minutes remaining in either regulation time or anytime during overtime and a minor or bench minor penalty is imposed for deliberate illegal substitution, such as too many players on the ice or leaving the penalty bench too soon, a penalty shot/optional bench minor shall be awarded against the offending team in lieu of the minor or bench minor penalty.

(Note) The intent of this rule is to award a penalty shot/optional bench minor only when the extra player(s) are "deliberately" put on the ice. When a substitution error is made and there are too many players on the ice the normal bench minor penalty shall be assessed regardless of the time remaining in the game.

- (d) A player serving a penalty on the penalty bench, who is to be changed after the penalty has been served, must proceed at once by way of the ice and be at his own players' bench before any change can be made.
- (e) During a stoppage of play a goalkeeper may not go to his players' bench without the permission of the Referee unless he is substituted for by another player or goalkeeper. When a substitution for the goalkeeper has been made under this rule, the goalkeeper shall not resume his position until the next stoppage of play, except that he shall be permitted immediate re-entry into the game when any penalty is imposed.
- (f) For a violation of this rule a bench minor penalty shall be imposed unless otherwise provided in the Playing Rules.

Rule 206. Injured Players

- (a) When a player, other than a goalkeeper, is injured or compelled to leave the ice during a game, he may retire from the game and be replaced by a substitute, but play must continue without the teams leaving the ice.
- (b) If a goalkeeper sustains an injury or becomes ill he must be ready to resume play immediately or be replaced by a substitute goalkeeper. No additional time shall be allowed by the Referee for the purpose of enabling the injured or ill goalkeeper to resume his position. (See also Rule 205(e).)
- (c) The substitute goalkeeper shall be subject to the regular rules governing goalkeepers and shall be entitled to the same privileges.
- (d) If a penalized player has been injured he may proceed to the dressing room without the necessity of taking a seat on the penalty bench.

If the injured player receives a minor penalty the penalized team shall immediately put a substitute player on the penalty bench who shall serve the penalty without change.

If the injured player receives a major penalty, the penalized team shall place a substitute player on the penalty bench before the penalty expires and no other replacement for the penalized player shall be permitted to enter the game except from the penalty bench.

The penalized player who has been injured and been replaced on the penalty bench shall not be eligible to play until his penalty has expired. However, if the injured player has recovered, he may replace the substitute player on the penalty bench at a stoppage of play prior to penalty expiration under this rule.

For a violation of this rule a bench minor penalty shall be imposed.

(Note) No substitution on the penalty bench is required under this rule for any player(s) who have been immediately substituted on the ice under Rule 402(f) - coincident minor penalties and/or Rule 403(c) - coincident major penalties.

- (e) When a player is injured so that he cannot continue play or go to his bench, the play shall not be stopped until the injured player's team has secured possession of the puck; if the player's team is in possession of the puck at the time of injury, play shall be stopped immediately, unless his team is in a scoring position.

(Note) In the case where it is obvious that a player has sustained a serious injury, the Referee and/or Linesman may stop the play immediately.

- (f) A player other than a goalkeeper, whose injury appears serious enough to warrant the stoppage of play, may not participate further in the game until the completion of the ensuing face-off.
- (g) A player or goalkeeper who is obviously bleeding shall be ruled off the ice immediately if observed during a stoppage of play. If observed during play, play shall be stopped immediately, and the bleeding player or goalkeeper then ruled off the ice. Said player or goalkeeper shall not be allowed to return to play until the bleeding has been stopped and the cut or abrasion covered. It is required that any affected equipment/uniform be properly decontaminated or exchanged.

Likewise, if an On-Ice Official is bleeding, at the next stoppage, said official shall seek treatment to stop the bleeding and cover the cut or abrasion before continuing. It is required that any affected equipment/uniform be properly decontaminated or exchanged.



**SECTION THREE
EQUIPMENT**

Rule 301. Sticks

- (a) The sticks shall be made of wood or other material approved by the Rules Committee, and must not have any projections. Adhesive tape of any color may be wrapped around the stick at any place for the purpose of reinforcement or to improve control of the puck. The end of a hollow stick must be fully covered.
- (b) No stick shall exceed 63 inches in length from the heel to the end of the shaft. The widened portion of the goalkeeper's stick extending up the shaft from the blade shall not extend more than 26 inches from the heel and shall not exceed 3-1/2 inches in width.

(Note) Requests for an exception to the length of the shaft (only) may be submitted in writing to and must be approved by the League prior to any such stick being approved for use.

The blade of a player's stick shall not exceed 12-1/2 inches from the heel to the end of the blade, nor shall the blade be more than 3 inches in width at any point nor less than 2 inches in width.

The blade of the goalkeeper's stick shall not be less than 2 inches in width at any point nor shall the blade exceed 3-1/2 inches in width at any point except at the heel where it must not exceed 4-1/2 inches in width, nor shall the goalkeeper's stick exceed 15-1/2 inches in length from the heel to the end of the blade.

All edges of the blade shall be beveled.

In the case of a goalkeeper's stick, there shall be a knob of light-colored tape or some other protective material approved by the League. Failure to comply with this provision of the rule will result in the goalkeeper's stick being deemed unfit for play. The goalkeeper's stick must be changed without the application of a minor penalty.

- (c) The curvature of the blade of the stick shall be restricted in such a way that the distance of a perpendicular line measured from a straight line drawn from the base of the heel to the base of the toe to the point of maximum curvature shall not exceed one-half inch.
- (d) A minor penalty shall be imposed on any player or goalkeeper who uses a stick not conforming to the provisions of this rule.

(Note 1) When a formal complaint is made by the Captain of a team against the dimensions of any stick, the Referee shall make the necessary measurement immediately.

If the complaint is not sustained, a bench minor penalty shall be imposed on the team requesting the measurement.

(Note 2) A player who participates in the play while carrying a stick to his goalkeeper shall incur a minor penalty under this rule.

(Note 3) If a goal is scored with an illegal stick, the proper penalty shall be assessed and the goal shall be allowed.

- (e) A minor plus a misconduct penalty shall be imposed on any player who refuses to surrender his stick for measurement when requested to do so by the Referee.
- (f) A minor penalty shall be assessed to a player or goalkeeper who participates in the play while he is in possession of more than one stick, except that no penalty shall be assessed to a player who is accidentally struck by the puck while he is carrying a replacement stick to a teammate.

Rule 302. Skates

- (a) All players and On-Ice Officials must wear hockey skates of a design approved by the Rules Committee. All skates worn by players (but not goalkeepers) and by the On-Ice Officials shall be equipped with approved safety heel tips, if so designed.

When the Referee becomes aware that any player is wearing skates on which the protective heel tip is missing or broken, if so designed, he shall order that player off the ice immediately and such player shall not be permitted to participate further in the game until the heel tip has been replaced.

It is recommended that all players (except goalkeepers) and On-Ice Officials wear skates with blades that have been approved by HECC.

- (b) The use of speed skates or fancy skates or any skate so designed that it may cause injury is prohibited.
- (c) No additional equipment or contrivance shall be attached to the skates of any player or goalkeeper.

Rule 303. Goalkeeper's Equipment

(NOTE) These equipment regulations are written in the spirit of "fair play." If at any time the League feels this spirit is being abused, the offending equipment will be deemed ineligible for play until a hearing has been conducted to rule on such equipment.

- (a) With the exception of skates and stick, all the equipment worn by the goalkeeper must be constructed solely for the purpose of protecting the head or body, and he must not wear any garment or use any contrivance which would give him undue assistance in keeping goal.

(Note) Cages on gloves and abdominal aprons extending down the front of the thighs on the outside of the pants are prohibited. "Cage" shall mean any lacing or webbing or other material in the goalkeeper's glove joining the thumb and index finger which is in excess of the minimum necessary to fill the gap when the goalkeeper's thumb and forefinger in the glove are fully extended and spread and includes any pocket or pouch effect produced by excess lacing or webbing or other material between the thumb and forefinger when fully extended or spread.

Protective padding attached to the back or forming part of goalkeeper's blocker glove shall not exceed eight inches in width nor more than sixteen inches in length at any point. The cuff of the goalkeeper's catching glove shall not exceed eight and one-half inches in width nor should the circumference of the glove exceed 48 inches. Any bar or attachment (cheater bar) between the cuff and the thumb shall only extend from the cuff to the thumb in a straight line. Any other pocket, pouch or contrivance added to the glove by a manufacturer or otherwise is not acceptable and makes the glove illegal.

- (b) The leg guards worn by goalkeepers shall not exceed twelve inches in extreme width when on the leg of the player. The maximum length from the bottom mid-point to the top mid-point of the leg guard is not to exceed thirty-eight inches. No attachments such as plastic puck foils are permitted. Calf protectors must follow the contour of the calf and ankle and can have a thickness of no greater than one and a half inches. The minimum length of the boot of the pads is to be no less than seven inches. The knee strap pad is not to exceed six inches in length by five and one-half inches in width by one and one-half inches in thickness. Thigh boards must follow the contour of the thighs at all times.

(Note) Randomly during the season, League staff shall check goalkeepers' leg guards and gloves. These inspections shall take place at the conclusion of a pre-determined and unannounced game. A member of the League Staff will enter each participating team's dressing room to obtain the equipment of all four participating goalkeepers.

Any violation of this rule will result in an automatic one game suspension for the next league game to the offending goalkeeper. Should both goalkeepers on the same team have illegal equipment, each will be suspended in sequence. The goalkeeper who played the day/night of the measurement will be suspended for the next game and the back-up goalkeeper will be suspended for the following game. Any violation of this rule shall be reported to the team and the League President.

Refusal to submit the equipment for League inspection will result in the same sanctions as that of a goalkeeper with illegal equipment. A second violation of this rule will result in additional suspensions and a team fine of up to five hundred dollars (\$500) per occurrence.

- (c) It is compulsory for all goalkeepers to wear helmets and full facemasks. Throat/neck protectors are recommended. No form fitted facemasks shall be permitted, with the following exception:

USA Hockey strongly recommends that all goalkeepers wear HECC approved facemasks. However, any such goalkeeper, having reached the age of majority and having signed the proper waiver, shall be permitted to wear a full mask of his/her choice or a form fitted facemask with a frontal wire insert, providing such mask includes a back skull plate in lieu of a HECC approved helmet. The signed waiver must be made available to Game Officials prior to each game, upon request.

- (d) A minor penalty shall be imposed on any goalkeeper using illegal equipment in a game.

If the decision as to the legality involves making any measurements or other examination which would cause any delay whatsoever, other than a stick measurement, such measurement or examination shall take place at the end of the first or second period or immediately in the third or overtime period. If such equipment is found to be illegal the penalty shall be announced and served immediately or following such intermission.

(e) Chest and Arm Pads

- (1) No raised ridges are allowed on the front edges or sides of the chest protector, the inside or outside of the arms, or across the shoulders.
- (2) Layering at the elbow is permitted to add protection but not to add stopping surface. This layering, both across the front and down the sides, to protect the point of the elbow shall not exceed seven and one-half inches.
- (3) Shoulder cap protectors must follow the contour of the shoulder without becoming a projection/extension beyond or above the shoulder or shoulder cap. The contoured padding must be not more than one inch in thickness beyond the top ridge of the shoulder and shoulder cap.
- (4) Each of the shoulder clavicle protectors are not to exceed seven inches in width. Their maximum thickness is to be five-eighths of an inch. This protection is not to extend or project above or beyond the shoulder or shoulder cap, nor extend beyond the armpit. No insert is allowed between the shoulder clavicle protector and the chest pad that would elevate the shoulder clavicle protector.
- (5) If, when the goalkeeper assumes the normal crouch position, the shoulder and/or shoulder cap protection is pushed above the contour of the shoulder, the chest pad will be considered illegal.

(f) Pants

- (1) No internal or external padding is permitted on the pant leg or waist beyond what is necessary to provide protection (no outside/inside ridges).
- (2) The maximum width (straight line) of the thigh pad across the front of the leg is eleven inches. If the groin and/or hip pads extend beyond the edge of the front thigh pad, they are to be included in this eleven inch measurement. This measurement is to be taken while the goalkeeper is in an upright standing position. This measurement is to be made five inches up from the bottom of the pants.

(g) Goalkeeper Jerseys

- (1) The maximum jersey size shall be the same as depicted below (1998-99 NHL Rule Book).
- (2) No inserts or additions are to be added to the standard goalkeeper cut jersey as produced by the manufacturer. Modifications at the manufacturer are not allowed.
- (3) No “tying down” of the sweater is allowed at the wrists if it creates a tension across the jersey such that a “webbing effect” is created in the armpit area.
- (4) No other tie downs are allowed that create a “webbing effect.”
- (5) The length of a jersey is illegal if it covers any area between the goalkeeper’s legs.

MAXIMUM JERSEY SIZE

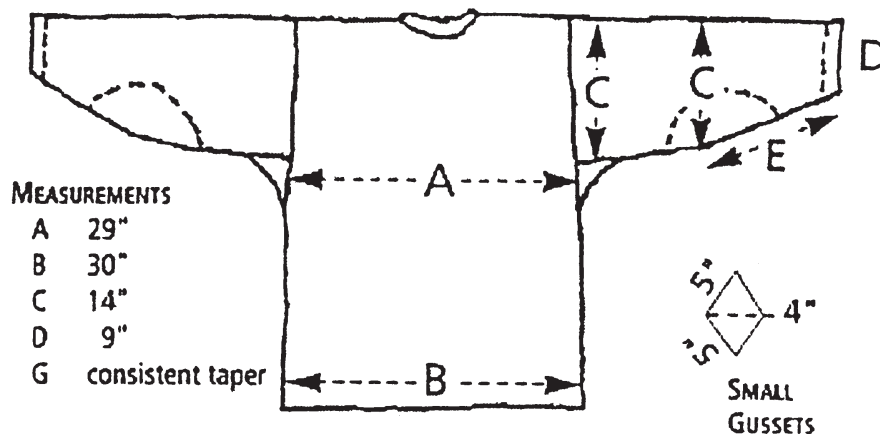

(h) Catching Glove

- (1) A maximum perimeter of 48 inches is permitted. The perimeter of the glove is the distance around the outer edges of the glove.
- (2) The wrist cuff is to be a minimum of four and one half inches in height. The cuff of the glove is considered to be the portion of the glove protecting the wrist from the point where the thumb joint meets the wrist. Any protection joining/enhancing the cuff to the glove will be considered part of the glove rather than the cuff.
- (3) The distance from the heel of the catching glove along the pocket and following the contour of the inside of the trap of the glove to the "T" trap must not exceed nineteen inches. The heel is considered to be the point at which the straight vertical line from the cuff meets the glove.

(i) Blocking Glove

- (1) Protective padding attached to the back or forming part of the goalkeeper's blocking glove shall not exceed eight inches in width nor more than sixteen inches in length at any point.

Rule 304. Protective Equipment

(Note) Although some protective equipment is not mandatory in all age classifications, USA Hockey strongly recommends that all players and goalkeepers in all age classifications properly wear an internal mouthpiece, a HECC approved helmet and a HECC approved full facemask for all games and practices.

- (a) Each participant is personally responsible to wear protective equipment for all games, warm-ups and practices. Such equipment should include gloves, shin pads, shoulder pads, elbow pads, hip pads or padded hockey pants, protective cup, tendon pads plus all head protective equipment as required by USA Hockey rules. It is recommended that all protective equipment be designed specifically for ice hockey.

All protective equipment, except gloves, padded hockey pants, helmet/facemask and goalkeeper's leg guards, must be worn under the uniform. For violation of this rule after a warning by the Referee a minor penalty shall be imposed.

(Note) Players, including goalkeepers, violating this rule shall not be permitted to participate in the game until such equipment has been corrected or removed.

A player, excluding the goalkeeper, whose helmet/facemask has come off his head during play may complete the play he is immediately involved in. Once the immediate play is completed, the player should immediately properly replace the helmet. Failure to do so will result in the following:

- (1) If the non-offending team has possession and control of the puck, the Referee shall allow play to continue until a change of possession or a stoppage of play occurs, or
- (2) If the offending player's team has possession and control of the puck, the Referee shall immediately stop play and the face-off will be conducted at the nearest Defending Zone face-off spot of the offending team.

If the goalkeeper's helmet/facemask comes off during play, the Referee shall stop play immediately. A minor penalty shall be assessed a goalkeeper who deliberately removes his helmet/facemask during play.

- (b) It is compulsory for all players in all classifications to wear a hockey helmet, with helmet strap properly fastened (see Rule 304(d) Note 2).

It is mandatory that all players wear a HECC approved helmet (including ear protection) with the following exception:

Players, having reached the age of majority, and who sign the proper waiver may wear a non-HECC approved helmet.

All players on the players' and the penalty bench must wear the protective helmet/facemask while in the bench area. For a violation of this rule, after a warning by the Referee, a misconduct penalty shall be assessed to the offending player.

- (c) All players, including goalkeepers, are required to wear a colored (non-clear) internal mouthpiece, which covers all the remaining teeth of one jaw, customarily the upper. It is recommended that the mouthpiece be form fitted by a Dentist.

For a violation of this rule a misconduct penalty shall be imposed. A game ejection penalty shall be assessed for a subsequent violation by the same player or goalkeeper in the same game.

A player or goalkeeper, having reached the age of majority, and who signs the proper waiver, shall be permitted to play with any mouthpiece or no mouthpiece at all. If the Captain of a team requests that a mouthpiece be checked on a player of the opposing team and the challenge is not sustained, a bench minor penalty for delay of game shall be imposed on the team requesting such check.

- (d) All players, including goalkeepers, are required to wear a facemask certified by HECC, plus any chin protection that accompanies the facemask, except as permitted in Note 1 of this rule.

(Note 1) Any player, having reached the age of majority, shall be permitted to sign the proper waiver and wear a HECC-approved half facemask shield. The face shield must be worn in the manner intended at all times. However, USA Hockey strongly recommends all players to wear full facial protection.

(Note 2) Any helmet or facemask that is altered except as permitted in Rule 304(d) Note 1 shall be deemed to be illegal equipment and shall not be allowed to be used in a game. (This shall include helmets from which a part has been cut or removed, facemasks from which the chin-cup has been removed or any other such alterations from the original manufacturing specifications.)

- (e) All players must wear the required protective equipment in the manner for which it is designed. For violation of this rule a misconduct penalty shall be imposed.

Rule 305. Dangerous Equipment

- (a) The use of pads or protectors made of metal, or of any other material likely to cause injury to a player, is prohibited.

(Note) All elbow pads which do not have a soft protective outer covering of sponge rubber or similar material at least one half (1/2) inch thick shall be considered dangerous equipment.

The wearing of casts or splints made of hard or unyielding materials is prohibited, even if padded, unless directed in writing by a licensed medical physician. Such casts or splints must be covered on all exterior surfaces with no less than 1/2-inch thick, high density, closed cell polyurethane or an alternate material of the same minimum thickness and similar physical properties to protect an injury.

- (b) A glove from which all or part of the palm has been removed or cut to permit the use of the bare hand shall be considered illegal equipment. A misconduct penalty shall be imposed on any player wearing such a glove in play.
- (c) No player or goalkeeper shall be permitted on the ice while wearing jewelry unless it is completely covered by equipment or taped to the body.

Rule 306. Puck

- (a) The puck shall be made of vulcanized rubber, or other approved material, one inch thick and three inches in diameter and shall weigh between five and one-half ounces and six ounces and be black in color.
- (b) The home team shall be responsible for providing an adequate supply of official pucks which shall be kept frozen. This supply of pucks shall be kept at the penalty bench under the control of one of the Off-Ice Officials.

Rule 307. Equipment Measurement

- (a) A request for measurement of any equipment covered by this section shall be limited to one request by each team during the course of any stoppage of play.
- (b) The Referee may, at his own discretion, measure any equipment, other than a stick, used for the first time in the game.
- (c) The Referee shall assess a bench minor penalty against a team that requests any measurement (excluding mouthpiece) if the measurement verifies that the equipment is legal.

Rule 308. Electronic Equipment

- (a) The use of one or two-way radios, lights or other electronic devices as a means of coaches or parents to communicate with players or goalkeepers shall be prohibited. For violation, the device will be removed and the team assessed a bench minor penalty.

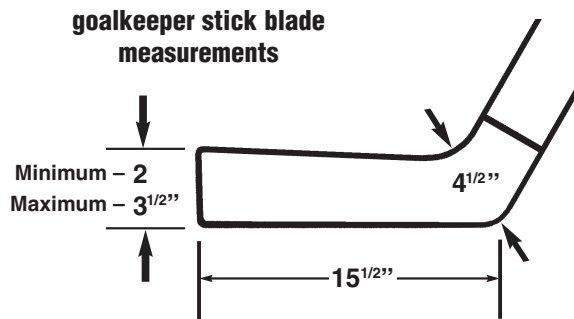
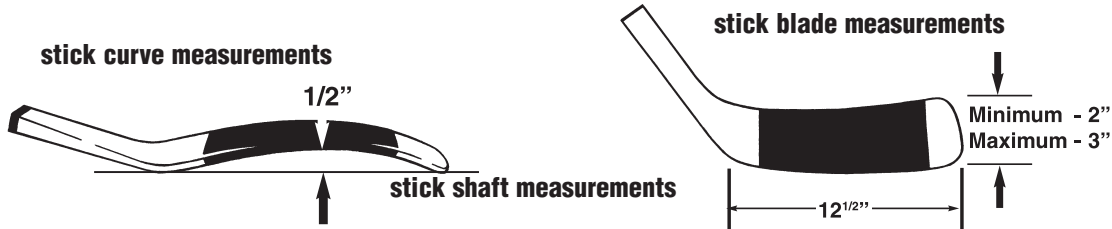
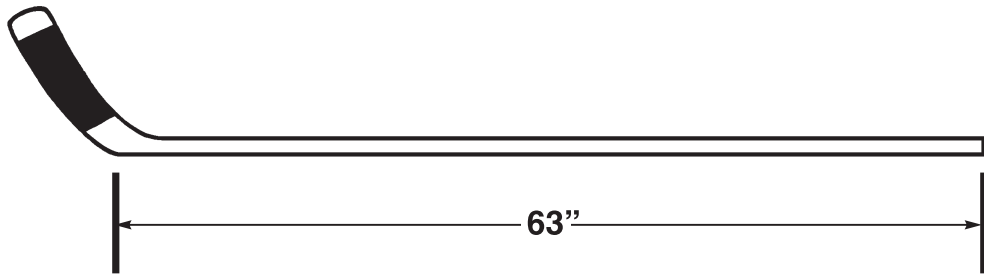

goalkeeper stick shaft measurements

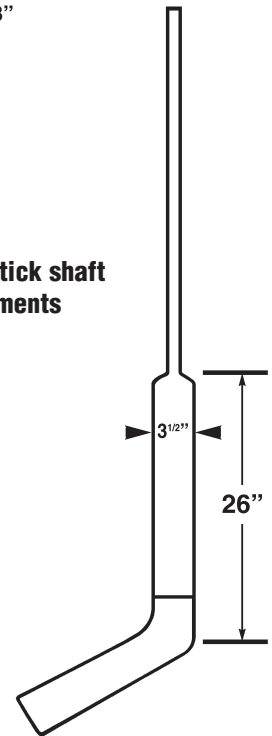

goalkeeper leg pad measurements

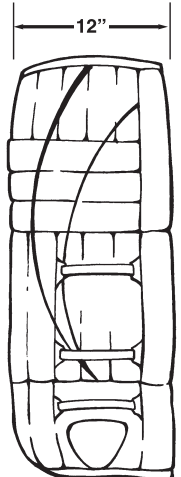

goalkeeper blocker measurements

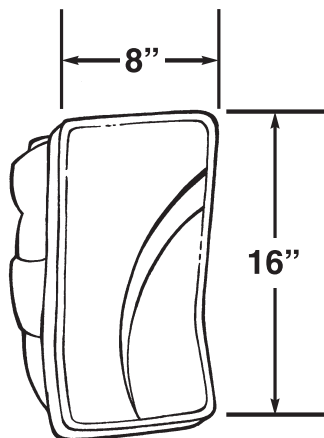

goalkeeper cuff measurements

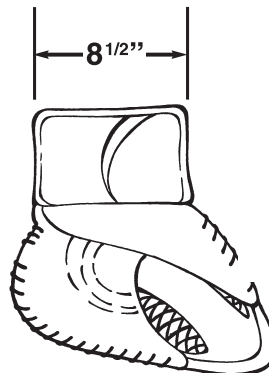

goalkeeper catching glove circumference

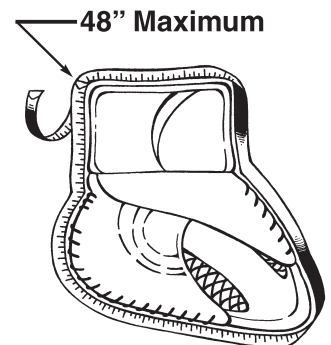



**SECTION FOUR
PENALTIES**

Rule 401. Penalties

- (a) Penalties shall be actual playing time and shall be divided into the following classes:
 - (1) Minor/Bench Minor Penalties
 - (2) Major Penalties
 - (3) Misconduct Penalties
 - (4) Match Penalties
 - (5) Penalty Shot

Where coincident penalties are imposed on players of both teams the penalized players of the visiting team shall take their positions on the penalty bench first in the place designated for visiting players, or where there is no special designation, then on the bench farthest from the gate.

(Note) When play is not actually in progress and an offense is committed by any player or Team Official, the same penalty shall apply as though play were actually in progress.

Rule 402. Minor Penalties

- (a) For a “MINOR PENALTY”, any player, other than a goalkeeper, shall be ruled off the ice for two minutes during which time no substitute shall be permitted.
- (b) For a “BENCH MINOR” penalty one player of the team against which the penalty is imposed shall be ruled off the ice for a period of two minutes, during which time no substitute shall be permitted. Any non-penalized player who was on the ice at the time of the infraction, except a goalkeeper, may be designated to serve the penalty by the Manager or Coach through the playing Captain and such player shall take his place on the penalty bench promptly.
- (c) If the opposing team scores a goal while a team is shorthanded (below the numerical strength of its opponent on the ice at the time of the goal) by one or more minor or bench minor penalties, one of such penalties shall automatically terminate (see Note).

(Note) “Shorthanded” means that the team must be below the numerical strength of its opponents on the ice at the time the goal is scored.

The penalty which terminates automatically is the first minor or bench minor penalty (non-coincident) then being served by the “shorthanded” team. Thus, if an equal number of players from each team is each serving a penalty(s) (minor, bench minor, major or match only), neither team is “shorthanded.”

This rule shall not apply when a goal is scored on a penalty shot or an awarded goal.

- (d) When the minor penalties of two players of the same team terminate at the same time the Captain of that team shall designate to the Referee which of such players will return to the ice first and the Referee will instruct the Penalty Timekeeper accordingly.
- (e) When a player receives a major penalty and a minor penalty at the same time the major penalty shall be served first by the penalized player except under Rule 403(c) in which case the minor penalty will be recorded and served first.

(Note) This applies to the case where BOTH penalties are imposed on the SAME player. See also Note to Rule 408 (Delayed Penalties).

- (f) When coincident minor penalties are imposed against players of both teams, the penalized players shall take their place on the penalty bench and such penalized players shall not leave the penalty bench until the first stoppage of play following the expiration of their respective penalties. Immediate substitutions shall be made for an equal number of minor penalties or coincident minor penalties of equal duration to each team so penalized and the penalties of the players for whom substitutions have been made shall not be taken into account for the purpose of a delayed penalty under Rule 408 (Delayed Penalties).

Rule 403. Major Penalties

- (a) For the first “MAJOR PENALTY” in any one game, the offender, except the goalkeeper, shall be ruled off the ice for five minutes, during which time no substitute shall be permitted.
- (b) For the second major penalty in the same game, excluding fighting majors, to the same player or goalkeeper, that player shall be assessed a game misconduct penalty in addition to the major penalty.

The penalized team shall place a substitute player on the penalty bench before the penalty expires and no other replacement for the penalized player shall be permitted to enter the game except from the penalty bench; for violation of this rule a bench minor penalty shall be imposed.

(Note) The Disciplinary Committee of the League or Tournament may impose a longer suspension or possible fines against the player’s team upon investigation of the incident.

- (c) When coincident major penalties or coincident penalties of equal duration including a major penalty are imposed against players of both teams, the penalized players shall all take their place on the penalty bench and such penalized players shall not leave the penalty bench until the first stoppage of play following the expiration of their respective penalties.

Immediate substitutions shall be made for an equal number of major penalties or coincident penalties of equal duration including a major penalty to each team so penalized and the penalties of the players for which substitutions have been made shall not be taken into account for the purpose of a delayed penalty under Rule 408 (Delayed Penalties).

- (d) Where it is required to determine which of the penalized players shall be designated to serve the delayed penalty under Rule 408 (Delayed Penalties), the penalized team shall have the right to make such designation not in conflict with Rule 402 (Minor Penalties).

Rule 404. Misconduct Penalties

- (a) A “MISCONDUCT” penalty involves the removal of a player, other than a goalkeeper, from the game for a period of ten minutes, but another player is permitted to immediately replace a player so removed. A player whose misconduct penalty has expired shall remain in the penalty bench until the next stoppage of play.

Unless immediate substitution is permitted under the coincident penalty rules 402(f) and 403(c), when a player receives a minor penalty plus a misconduct, game misconduct or a gross misconduct penalty at the same time, the penalized team shall immediately place an additional non-penalized player other than a goalkeeper on the penalty bench and such player may not be changed.

If a player receives a major plus a misconduct penalty, the penalized team shall place a substitute player on the penalty bench before the major penalty expires and no replacement for the penalized player shall be permitted to enter the game except from the penalty bench.

Any violation of this provision shall be treated as illegal substitution under Rule 205 (Change of Players) calling for a bench minor penalty.

- (b) A “GAME EJECTION” or “EJ” penalty involves the suspension of a player or Team Official for the balance of the game but another player is permitted to immediately replace a player so removed.

(Note 1) The Referee is required to report all Game Ejection penalties and the surrounding circumstances to the proper authorities.

(Note 2) For a Game Ejection penalty regardless of when imposed, a total of ten minutes shall be charged in the records against an offending player.

No player may be assessed a Game Ejection penalty during the last five minutes of the third period or any part of overtime. If a player receives a major penalty which would normally incur a Game Ejection penalty, the Referee shall have no alternative but to assess a Game Misconduct penalty in lieu of the Game Ejection. A Game Ejection penalty may be assessed if associated with a double minor penalty under Rule 607(a) - Checking from Behind, Rule 608(c) - Butt-Ending, Rule 603(d) - Head-Butting, or Rule 634(a) - Sparring.

- (c) A “GAME MISCONDUCT” penalty involves the suspension of a player or Team Official for the balance of the game, but another player is permitted to immediately replace a player removed. A player or Team Official incurring a game misconduct penalty shall be suspended for the next scheduled League game.
- (d) In regular league games, any player who incurs a total of three misconduct penalties, other than those associated with automatic penalties, shall be suspended for the next league game of his team. For every three

additional misconduct penalties assessed to the same player, the suspension shall be increased by one additional game.

In playoff games, any player who incurs a total of three misconduct penalties, other than those associated with automatic penalties, shall be suspended for the next playoff game of his team. For every three additional misconduct penalties assessed to the same player, he shall be suspended for one game.

(Note) If a player receives a suspension that he is unable to serve at the end of the season or playoffs, the following shall happen:

(1) *The player shall be suspended for the remaining game(s) at the beginning of the following season.*

(2) *The team must “buy out” the suspension if the player is not returning at a cost of up to a fifty dollar (\$50) filing fee and up to one hundred dollars (\$100) per unserved suspended game.*

- (e) A “GROSS MISCONDUCT” penalty involves the suspension of a player or Team Official for the balance of the game, but another player is permitted to immediately replace a player so removed.

(Note 1) The Referee is required to report all gross misconduct penalties and the surrounding circumstances to the proper authorities immediately following the game in which they occur.

(Note 2) For all game misconduct and gross misconduct penalties regardless of when imposed, a total of ten minutes shall be charged in the records against an offending player.

- (f) There shall be two classifications under this rule - Gross Misconduct and Gross Misconduct II. A player or Team Official incurring a Gross Misconduct penalty shall be suspended for the next scheduled League game and may be fined up to one thousand five hundred dollars (\$1,500). A player or Team Official incurring a Gross Misconduct II penalty shall be suspended for the next three scheduled League games and may be fined up to two thousand five hundred dollars (\$2500). In either case, said player or Team Official may be subject to further suspension following a hearing at the discretion of the proper authorities.
- (g) If any Team Official is assessed a game misconduct or a gross misconduct penalty, he may not sit near the bench of his team, nor in any way attempt to direct the play of his team. While serving any suspension under Rule 404, a Team Official shall not direct his team or have contact with any team member or game official for a period of time thirty minutes prior to the scheduled game time and until ten minutes after the conclusion of the game. For the violation of this rule the Team Official suspension shall be considered unserved and the team may be subject to an additional fine of up to five hundred dollars (\$500) per occurrence, plus the forfeiture of any game the Team Official is found to have violated the suspension.

Rule 405. Match Penalties

- (a) A “MATCH” penalty involves the suspension of a player for the balance of the game, and the offender shall be ordered to the dressing room immediately. Unless immediate substitution is permitted under the coincident penalty rules 403(c) and 405(b), the penalized team shall immediately place a non-penalized player other than a goalkeeper on the penalty bench to serve the time portion (five minutes) of the match penalty, as prescribed by the applicable rule, and such player may not be changed. The player shall also serve any additional minor or major penalty assessed to the offending player unless immediate substitution is permitted under the coincident penalty rules 402(f) and 403(c).

Such substitute player must enter the penalty bench in accordance with Rule 404(a).

(Note) For all “MATCH” penalties, regardless of when imposed, or prescribed additional penalties, a total of ten minutes shall be charged in the records against the offending player.

- (b) When coincident match penalties have been imposed or when any combination of coincident major and match penalties have been imposed on a player or players of both teams, Rule 403(c) covering coincident major penalties will be applicable with respect to player substitutions.
- (c) A player incurring a match penalty shall be suspended for the next two League games, plus a hearing (the player may be subject to further suspension).

(Note) The Referee is required to report all match penalties and the surrounding circumstances to the proper authorities immediately following the game in which they occur.

Rule 406. Penalty Shot

- (a) Any infraction of the rules which calls for a "Penalty Shot" shall be taken as follows:

The Referee shall cause to be announced over the public address system the name of the player designated by him or selected by the team entitled to take the shot (as appropriate) and shall then place the puck on the center face-off spot and the player taking the shot will, on the instruction of the Referee, play the puck from there and shall attempt to score on the goalkeeper. Once the player taking the shot has touched the puck, it must be kept in motion towards the opponent's goal line and once it is shot the play shall be considered complete. No goal can be scored on a rebound of any kind and any time the puck crosses the goal line the shot shall be considered complete.

Only a player designated as a goalkeeper, substitute goalkeeper or temporary goalkeeper (see Glossary) may defend against a penalty shot.

- (b) The goalkeeper must remain in his crease until the player taking the penalty shot has touched the puck and in the event of violation of this rule or any foul committed by a goalkeeper the Referee shall allow the shot to be taken and if the shot fails he shall permit the penalty shot to be taken again.

The goalkeeper may attempt to stop the shot in any manner except by throwing his stick or any object, in which case a minor penalty shall be assessed to the goalkeeper, whether or not a goal is scored on the penalty shot.

(Note) See Rule 636 (Throwing Stick).

- (c) In cases where a penalty shot has been awarded under Rule 609(c)-deliberately displacing goalpost or removing helmet/facemask during a breakaway, Rule 621(f)-interference, under Rule 625(g)-for illegal entry into the game, under Rule 636(a)-for throwing a stick and under Rule 639(c)-for fouling from behind, the Referee shall designate the player who has been fouled as the player who shall take the penalty shot.

In cases where a penalty shot has been awarded under Rule 205(c)-deliberate illegal substitution with less than two minutes remaining in regulation time or anytime during overtime, under Rule 609(c)-deliberately displacing goalpost with less than two minutes remaining in regulation time or anytime during overtime, Rule 612(c)-falling on the puck in the crease or Rule 615(d)-picking up the puck from the crease area, the penalty shot shall be taken by a player selected by the Captain of the non-offending team from the players on the ice at the time the foul was committed. Such selection shall be reported to the Referee and cannot be changed.

If by reason of injury the player designated by the Referee to take the penalty shot is unable to do so within a reasonable time, the shot may be taken by a player selected by the Captain of the non-offending team from the players on the ice at the time the foul was committed. Such selection shall be reported to the Referee and cannot be changed.

If the offense for which the penalty shot was awarded was such as would normally incur a minor or bench minor penalty, the non-offending team may, prior to the penalty shot, elect that the minor or bench minor penalty be assessed to the offending player or team in lieu of the penalty shot.

- (d) Should the player in respect to whom a penalty shot has been awarded himself commit a foul in connection with the same play or circumstances, either before or after the penalty shot has been awarded, be designated to take the shot, he shall first be permitted to do so before being sent to the penalty bench to serve the penalty, except when such a penalty is for a game ejection, game misconduct, gross misconduct or match penalty, in which case the penalty shot shall be taken by a player selected by the Captain of the non-offending team from the players on the ice at the time the foul was committed.

If, at the time a penalty shot is awarded, the goalkeeper of the penalized team has been removed from the ice for another player, the goalkeeper shall be permitted to return to the ice before the penalty shot is taken.

- (e) While the penalty shot is being taken, all non-penalized players of both sides shall remain off the ice on their respective players' bench.
- (f) If, while the penalty shot is being taken, any player of the opposing team shall have by some action interfered with or distracted the player taking the shot and because of such action the shot should have failed, a second attempt shall be permitted and the Referee shall impose a misconduct penalty on the player so interfering or distracting.
- (g) If a goal is scored from a penalty shot, the puck shall be faced at center ice in the usual way. If a goal is not scored, the puck shall be faced at either of the end face-off spots in the zone in which the penalty shot has been tried.

- (h) Whether or not a goal is scored from a penalty shot, if the offense for which the penalty shot was awarded was such as to incur:
 - 1) a major, match or misconduct penalty, such penalty shall be imposed in addition to the penalty shot.
 - 2) a minor or bench minor penalty, the offending team shall not be reduced in on-ice strength as a result.
- (i) If the foul upon which the penalty shot is based occurs during actual playing time, the penalty shot shall be awarded and taken immediately in the usual manner, notwithstanding any delay occasioned by a slow whistle by the Referee to permit the play to be completed which delay results in the expiration of the regular playing time in any period.

The time required for the taking of a penalty shot shall not be included in the regular playing time or any overtime.

Rule 407. Goalkeepers Penalties

- (a) A goalkeeper shall not be sent to the penalty bench for an offense which incurs a minor, major or misconduct penalty, but instead any of these penalties shall be served by another member of his team who was on the ice when the offense was committed, such player to be designated by the Manager or Coach of the offending team through the Captain and such substitute shall not be changed.
- (b) Should a goalkeeper incur a game misconduct penalty, his place will be taken by a member of his own team, or by a substitute or temporary goalkeeper who is available, and such player will be allowed the goalkeeper's full equipment. He shall also be suspended under the appropriate game misconduct rule (404(d)).
- (c) Should a goalkeeper incur a match penalty, his place will be taken by a member of his own team, or by a substitute goalkeeper who is available, and such player will be allowed the goalkeeper's equipment. However, any additional penalties as specifically called for by the individual rules covering match penalties will apply, and the offending team shall be penalized accordingly; such additional penalty to be served by another member of the team on the ice at the time the offense was committed, said player to be designated by the Manager or Coach of the offending team through the Captain.
- (d) A minor penalty shall be imposed on a goalkeeper who leaves the immediate vicinity of his crease during an altercation.

(Note) All penalties imposed on a goalkeeper, regardless of who serves the penalty, or any substitution, shall be charged in the records against the goalkeeper.
- (e) If a goalkeeper deliberately participates in the play in any manner when he is beyond the center red line, a minor penalty shall be imposed upon him.

Rule 408. Delayed Penalties

- (a) If a third player of any team shall be penalized while two players of the same team are serving penalties, the penalty time of the third player shall not commence until the penalty time of one of the two players already penalized shall have elapsed. Nevertheless, the third player penalized must at once proceed to the penalty bench and may be replaced by a substitute until such time as the penalty time of the penalized player shall commence.
- (b) When any team shall have three players serving penalties at the same time and because of the delayed penalty rule a substitute for the third offender is on the ice, none of the three penalized players on the penalty bench may return to the ice until play has been stopped. When play has been stopped, the player whose full penalty has expired may return to the play.

Provided, however, that the Penalty Timekeeper shall permit the return to the ice in the order of expiration of their penalties, of a player or players when by reason of the expiration of their penalties the penalized team is entitled to have more than four players on the ice.
- (c) In the case of delayed penalties, the Referee shall instruct the Penalty Timekeeper that the penalized players whose penalties have expired shall only be allowed to return to the ice when there is a stoppage of play.

When the penalties of two players of the same team will expire at the same time the Captain of that team will designate to the Referee which of such players will return to the ice first and the Referee will instruct the Penalty Timekeeper accordingly.

When a major and a minor penalty are imposed at the same time on players of the same team, the Penalty Timekeeper shall record the minor as being the first of such penalties.

(Note) This applies to the case where the two penalties are imposed on DIFFERENT players of the same team. See also Rule 402(e) (Note), (Minor Penalties).

Rule 409. Calling of Penalties

- (a) Should an infraction of the rules be committed by a player of the team in possession and control of the puck, the Referee shall immediately stop play and assess the penalty(s) to the offending player(s).

The resulting face-off shall be made at the place where the play was stopped unless the stoppage occurs in the Attacking Zone of the player penalized in which case the face-off shall be made at the nearest face-off spot in the Neutral Zone.

- (b) Should an infraction of the rules be committed by a player of a team NOT in possession and control of the puck the Referee shall signify the calling of a penalty by raising his arm and upon completion of the play by the team in possession will immediately stop play and assess the penalty to the offending player.

(Note 1) There shall be no signal given by the Referee for a misconduct or game misconduct penalty under this section.

(Note 2) "Completion of the play by the team in possession" in this rule means that the puck must have come into the possession and control of an opposing player or goalkeeper, or has been "frozen". This does not mean a rebound off the goalkeeper, the goal or the boards or any accidental contact with the body or equipment of an opposing player.

The resulting face-off shall be made at the place where the play was stopped, unless during the period of a delayed whistle due to a foul by a player of the team NOT in possession, the team in possession ices the puck, shoots the puck from its Defending Zone so that it goes out of bounds or is unplayable then the face-off following the stoppage shall take place in the Neutral Zone near the defending blue line of the team shooting the puck.

If the penalty or penalties to be imposed are minor penalties and a goal is scored on the play by the non-offending team, the first minor penalty shall not be imposed but all other penalties shall be imposed in the normal manner regardless of whether or not a goal is scored.

- (c) If after the Referee has signaled a penalty but before the whistle has been blown the puck shall enter the goal of the non-offending team as the direct result of the action of a player of that team, the goal shall be allowed and the penalty signaled shall be imposed in the normal manner.
- (d) If the Referee signals an additional minor penalty(s) against a team that is already shorthanded (below the numerical strength of its opponent on the ice at the time of the goal) because of one or more minor or bench minor penalties, and a goal is scored by the non-offending team before the whistle is blown, the goal shall be allowed, the delayed penalty(s) shall be assessed, and the first non-coincident minor penalty already being served shall terminate automatically under Rule 402(c) (Minor Penalties).
- (e) Should the same offending player commit other fouls on the same play, either before or after the Referee has blown his whistle, the offending player shall serve such penalties consecutively.
- (f) All minor and bench minor penalties occurring after a goal has been scored or during the stoppage of play when a penalty shot is being attempted, shall be served in the normal manner under this rule.

Rule 410. Supplementary Discipline

- (a) In addition to the suspensions imposed under these rules, the proper disciplinary authority may, at the conclusion of the game, at their discretion, investigate any incident that occurs in connection with any game and may assess additional suspensions for any offense committed before, during the course of a game, or any aftermath thereof by a player or Team Official, whether or not such offense has been penalized by the Referee. The proper disciplinary authority shall be the President/Commissioner, Referee-in-Chief and/or a League-appointed person.
- (b) Suspensions imposed during a USA Hockey National Championship must be served during the same play-off or championship. If the length of suspension carries beyond that championship, the Discipline Committee of the League shall be the sole authority in the determination of the eligibility of the individual(s).

(Note) Players who are suspended by action of the Discipline Committee, whose suspension extends beyond their eligibility for competition in the League, shall be served by the offending player's team in either of the following fashions:

- (1) The team may be fined up to one hundred dollars (\$100) per game of the unexpired suspensions; or*
 - (2) The team may choose to play "short" for the number of games necessary to serve the offending player's suspension.*
- (c) In the case of a Gross Misconduct penalty or a Match penalty, the proper disciplinary authority (as defined in the Glossary) shall be required to conduct any disciplinary actions in accordance with the provisions of USA Hockey's "Resolutions of Disputes, Arbitration, and Suspensions" section of the current USA Hockey Annual Guide.
- (d) All suspensions incurred during League play or League playoffs which require a player or Team Official to be suspended for more than two games and/or fines over two hundred fifty dollars (\$250) shall be reported by the League to the USA Hockey Junior Registrar.



**SECTION FIVE
OFFICIALS**

Rule 501. Appointment of Officials

- (a) The Referee-in-Chief or his duly appointed representative shall appoint only properly registered USA Hockey Referees and Linesmen. Member clubs of the League shall appoint a Game Timekeeper, Penalty Timekeeper, Official Scorer and two Goal Judges for each game. Failure to appoint an Off-Ice Official may result in a fine not to exceed fifty dollars (\$50) per unassigned official.

(Note) The official method of refereeing Junior hockey League games is the three-man system: one Referee and two Linesmen.

Rule 502. Referee

- (a) The REFEREE shall have general supervision of the game, and shall have full control of all game officials, team officials and players before, during and after the game, including stoppages; and in case of any dispute, his decision shall be final. The Referee may not change the decision, or that of any other official, after the resumption of play following the rendering of the original decision.

On-Ice Officials should enter the ice surface prior to warm-ups and remain on the ice at the conclusion of each period until all players have proceeded to their dressing rooms. Penalties may also be assessed during the warm-up period.

- (b) All On-Ice Officials shall wear black trousers, official sweaters and a black hockey helmet, with helmet strap fastened. It is strongly recommended that all On-Ice Officials wear a half-shield visor properly attached to their helmet. All On-Ice Officials shall wear the current USA Hockey officiating crest on the left chest of the sweater during all games. Any other crest that is worn must be located on either arm of the sweater. They shall be equipped with whistles and metal tape measures with minimum length of six feet. Officials shall wear a nameplate or identifying number (regulated by each League) on the back of the sweater for all League, playoff and National Tournament games.

It is required that all On-Ice Officials wear a black hockey helmet with the helmet strap fastened. It is strongly recommended that all On-Ice Officials wear a half shield visor properly attached to their helmet.

- (c) The Referee shall order the teams on the ice at the appointed time for the beginning of a game, and at the commencement of each period. If for any reason there are more than fifteen minutes delay in the commencement of the game or any undue delay in resuming play after the fifteen minute intervals between periods, the Referee shall state in his report to the proper authorities the cause of the delay, and the team or teams which were at fault.
- (d) When he becomes aware of any lack of conformity to the regulations on equipment, it shall be his duty to see that the required equipment is in use.
- (e) The Referee shall, before starting a game, see that the appointed Game Timekeeper, Penalty Timekeeper, Official Scorer and Goal Judges are in their respective places, and satisfy himself that the timing and signaling equipment is in order and the ice surface is satisfactory.
- (f) It shall be his duty to impose such penalties as are prescribed by the rules for infractions thereof, and he shall give the final decision in matters of disputed goals. The Referee may consult with the Linesmen or Goal Judges before making his decision.
- (g) The Referee shall announce to the Official Scorer or Penalty Timekeeper all goals and assists legally scored as well as penalties, and for what infractions such penalties are imposed. By league directive, an officially appointed designee may award assists.

The Referee shall cause to be announced over the public address system the reason for not allowing a goal every time the goal signal light is turned on in the course of play. This shall be done at the first stoppage of play regardless of any signal given by the Referee when the goal signal light was put on in error.

The Referee shall report to the Official Scorer the name or number of the goal scorer and any players entitled to assists.

(Note) The name of the scorer and any player entitled to an assist will be announced on the public address system. In the event that the Referee disallows a goal for any violation of the rules, he shall report the reason for disallowance to the Official Scorer who shall announce the Referee's decision over the public address system.

The infraction of the rules for which each penalty has been imposed will be announced correctly, as reported by the Referee, over the public address system. Where players of both teams are penalized on the same play, the penalty to the visiting player will be announced first.

- (h) The Referee shall see to it that players of opposing teams are separated on the penalty bench to prevent feuding.
- (i) If, through misadventure or sickness, the Referee and/or Linesmen appointed are prevented from appearing, the Managers or Coaches of the two teams shall agree on a Referee and Linesmen. If they are unable to agree, they shall appoint a player from each team who shall act as Referee and Linesman; the player of the home team acting as Referee, and the player of the visiting team as Linesman.
- (j) If the regularly appointed officials appear during the progress of the game, they shall at once replace the temporary officials.
- (k) Should an appointed Linesman be unable to act at the last minute or through sickness or accident be unable to finish the game, the Referee shall have the power to appoint another, in his stead, if he deems it necessary, or if required to do so by the Manager or Coach of either of the competing teams.
- (l) If for any reason one Official is unable to continue to officiate (three-official system), the game shall be officiated with one Referee/one Linesman or with two Referees as mandated by the local governing body.
- (m) The Referee shall check team rosters and all players in uniform before signing reports of the game.

Rule 503. Linesman

- (a) The duties of the LINESMAN are to determine any infractions of the rules concerning off-side play at the blue lines, or center line, or any violation of the “Icing the Puck” rule.

He shall stop play when the puck goes outside the playing area, when it is interfered with by any ineligible person, and when it is struck above the height of the shoulder, when it is passed to a teammate with the hand and when the goal post has been displaced from its normal position. When he is in the vicinity of the goal, he shall stop play when he observes the puck enter the goal. He shall stop play for off-sides occurring at the face-off circles. He shall stop play when there has been a premature substitution for a goalkeeper under Rule 205(a) (Change of Players), for injured players under Rule 206(e), and interference by spectators under Rule 622(a).

- (b) He shall conduct the face-off at all times, except at the start of the game, at the beginning of each period and after a goal has been scored.

The Referee may call upon a Linesman to conduct a face-off at any time.

- (c) He shall, when requested to do so by the Referee, give his version of any incident that may have taken place during the playing of the game.

- (d) He shall not stop play to report any penalty except any violation of Rule 205(a) and (c), Change of Players (too many players on the ice) and any violation of Rules 601(c.2) and 601(h.3) (articles thrown on the ice from vicinity of players’ or penalty bench), and he shall report such violation to the Referee who shall impose a bench minor penalty against the offending team.

He shall report immediately to the Referee his version of the circumstances with respect to Rule 609(c) (delaying the game by deliberately displacing the goal post from its normal position).

He shall report to the Referee at the next stoppage of play his version of any infraction of the rules which he believes constitutes a bench minor, major, match, misconduct, game ejection, game misconduct, gross misconduct penalty or penalty shot under these rules, or any Injury Potential Penalty (See Glossary) that occurs behind the play and is not observed by the Referee. The Referee, at his discretion, may assess a penalty for such infractions.

- (e) Should an Official accidentally leave the ice or receive an injury which incapacitates him from discharging his duties while play is in progress, the game shall be immediately stopped by an On-Ice Official.

Rule 504. Goal Judge

- (a) There shall be one GOAL JUDGE at each goal. They shall not be members of either team engaged in a game, nor shall they be replaced during its progress unless after the commencement of the game it becomes apparent that either Goal Judge, on account of partisanship or any other cause, is guilty of giving unjust decisions, in which case the Referee may appoint a replacement.
- (b) Goal Judges shall be stationed behind the goals during the progress of play, in properly screened cages, so that there can be no interference with their activities; and they shall not change goals during the game.
- (c) In the event of a goal being claimed, the Goal Judge of that goal shall decide whether or not the puck has passed between the goal posts, under the crossbar and entirely over the goal line. His decision is simply “goal” or “no goal”.

Rule 505. Penalty Timekeeper

- (a) The PENALTY TIMEKEEPER shall keep, on the official forms provided, a correct record of all penalties imposed by the On-Ice Officials including the names of the players penalized, the infractions penalized, the duration of each penalty and the time at which each penalty was imposed. He shall report in the Penalty Record each penalty shot awarded, the name of the player taking the shot and the result of the shot.
- (b) The Penalty Timekeeper shall check and ensure that the time served by all penalized players is correct. He shall be responsible for the correct posting of all penalties on the scoreboard at all times and shall promptly call to the attention of the Referee any discrepancy between the time recorded on the clock and the official correct time and he shall be responsible for making any adjustments ordered by the Referee.

He shall, upon request, give a penalized player correct information as to the unexpired time of his penalty.

(Note 1) The infraction of the rules for which each penalty has been imposed will be announced twice over the public address system as reported by the Referee. Where players of both teams are penalized on the same play, the penalty to the visiting player will be announced first.

(Note 2) Misconduct penalties and coincident minor or major penalties should not be recorded on the timing device, but such penalized players should be alerted and released at the first stoppage of play following the expiration of their penalties.

Rule 506. Official Scorer

- (a) Before the start of the game, the OFFICIAL SCORER shall obtain from the Manager or Coach of both teams a list of all eligible players of each team, which information shall be made known to the opposing team Manager or Coach before the start of play, either personally or through the Referee.

The Official Scorer shall secure the names of the Captain and Designated Alternate from the Manager or Coach and will so indicate by placing the letter “C” or “A” opposite their names on the scoresheet. The Official Scorer shall indicate the name of each head coach of each team on the scoresheet. This information shall be presented to the Referee for his signature at the completion of the game. He shall also be responsible to obtain and record the starting lineup of each team.

- (b) The Official Scorer shall keep a record of the goals scored, the scorers, and players to whom assists have been credited, and shall indicate those players on the lists who have actually taken part in the game. He shall also record the time of entry into the game of any substitute or temporary goalkeeper. He shall record on the Official Scoresheet a notation where a goal is scored when the goalkeeper has been removed from the ice.
- (c) The awards of points for goals and assists shall be announced over the public address system and all changes in such awards shall also be announced in the same manner.

No requests for changes in any award of points shall be considered unless they are made at or before the conclusion of actual play in the game by the team Captain.

- (d) The Official Scorer shall also prepare the Official Scoresheet for signature by the Referee and forward it to the proper authorities.

Rule 507. Game Timekeeper

- (a) The GAME TIMEKEEPER shall signal the Referee and the competing teams for the start of the game and each succeeding period, and the Referee shall start the play promptly in accordance with Rule 637 (Time of Match). To assist in assuring the prompt return to the ice of the teams and On-Ice Officials, the Game Timekeeper shall give a preliminary warning three minutes prior to the resumption of play in each period.
- (b) If the rink is not equipped with an automatic gong, bell or siren, or if such device fails to function, the Game Timekeeper shall signal the end of each period by ringing a gong or bell or by blowing a whistle.
- (c) He shall cause to be announced on the public address system at the appropriate time in each period that there is one minute remaining to be played in the period.
- (d) The Game Timekeeper shall not sound the horn or buzzer during play to notify the Referee of a malfunction of the clock or any other equipment. He shall note the time and, when play is stopped, notify the Referee of the problem. In the event of any dispute regarding time, the matter shall be referred to the Referee for adjustment, and his decision shall be final.

Rule 508. Proper Authorities

- (a) The term “proper authorities” or “proper disciplinary authority” as applied under these rules is defined as the immediate governing body of the team or teams involved.
- (b) Original jurisdiction in any hearing resulting from a gross misconduct penalty assessed under Rule 601(g)1 or 601(j)1 (Physical Assault of Officials) shall reside with the Junior Council sanctioned league.
- (c) Original jurisdiction in any hearing resulting from a gross misconduct penalty assessed under Rule 601(g)2, 601(g)3, 601(j)2 or 601(j)3 shall reside with the Proper Authorities of the appropriate team.



SECTION SIX
PLAYING RULES

Rule 601. Abuse of Officials and other Misconduct

(Note) In the enforcement of this rule the Referee has, in many instances, the option of imposing a “bench minor penalty”, “minor penalty” or a “misconduct penalty.” In principle the Referee is directed to impose a “bench minor penalty” in respect to the violations which occur on or in the immediate vicinity of the players’ bench but off the playing surface, and in all cases affecting non-playing personnel or players. A “minor penalty” or “misconduct penalty” should be imposed for violations which occur on the playing surface or in the penalty bench area and where the penalized player is readily identifiable.

An infraction covered under Rules 601(a) through (c) which occurs after the game shall be initially penalized under Rule 601(d).

- (a) Any player who challenges or disputes the rulings of any Official or endeavors to incite an opponent (including taunting) or create a disturbance during the game shall be assessed a minor penalty for unsportsmanlike conduct. If the player persists in such challenge or dispute, he shall be assessed a misconduct penalty, and any further dispute by the same player will result in a game ejection and/or game misconduct penalty being assessed.

(NOTE) The penalty following the misconduct shall be a game ejection, but under this rule a player may also be assessed a game misconduct penalty along with or in lieu of a game ejection.

- (b) Any player who shoots the puck after the whistle has been blown shall be assessed a minor penalty for unsportsmanlike conduct if, in the opinion of the Referee, the player had sufficient time after the whistle to refrain from taking such shot.
- (c) If any player is guilty of any one of the following, his team shall be assessed a bench minor penalty:
 - 1. In the vicinity of the players’ bench, using obscene, profane or abusive language to any person or using the name of any Official coupled with any vociferous remarks.
 - 2. In the vicinity of the players’ bench or penalty bench, throwing anything into the playing area during the progress of the game or during a stoppage of play.
- (d) If any player is guilty of any one of the following, he shall be assessed a misconduct penalty:
 - 1. Using obscene, profane or abusive language to any person on the ice or anywhere in the rink before, during or after the game.
 - 2. During a stoppage, intentionally knocking, throwing or shooting the puck out of reach of an Official who is retrieving it.
 - 3. Deliberately throwing the stick, or any other equipment, out of the playing area at any time.
 - 4. After being penalized, not proceeding directly and immediately to the penalty bench and taking his place on the penalty bench, or to the dressing room, when so ordered by the Referee (gloves, stick, etc., shall be delivered to him at the penalty bench or dressing room by a teammate).
 - 5. Entering or remaining in the Referee’s crease while the Referee is reporting to, or consulting with, any Game Official including Linesmen, Timekeeper, Penalty Timekeeper, Official Scorer or Announcer except for the purpose of taking his place on the penalty bench.
 - 6. Interfering in any non-physical manner with any Game Official including Referee, Linesman, Timekeepers or Goal Judges in the performance of their duties.
 - 7. After the third set of coincidental minor penalties are assessed to players under Rule 609(g) and after a warning is issued to both benches, subsequent players are assessed Misconduct penalties under Rule 609(g).
- (e) If any player is guilty of any one of the following, he shall be assessed a misconduct or game ejection or game misconduct penalty:
 - 1. Touching or holding the Referee, Linesman, or any other Game Official with his hand or stick.
 - 2. Continuing or attempting to continue a fight or altercation after he has been ordered by the Referee to stop, or resisting the Linesman in the discharge of his duties.
 - 3. Intentionally banging the boards, protective glass, dasher boards or goal with a stick or any other instrument at any time. (If the offense is committed in protest of an official’s decision, a minor penalty for unsportsmanlike conduct plus a misconduct or game misconduct shall be assessed the offending player.)

- (f) If any player is guilty of any one of the following, he shall be assessed a game misconduct penalty:
1. Persisting in any course of conduct for which he has previously been assessed a misconduct penalty.
 2. Using obscene gestures, or racial/ethnic slurs, on the ice or anywhere in the rink before, during or after the game.
- (g) If any player is guilty of any of the following, he shall be assessed a gross misconduct penalty:
1. Deliberately inflicting physical harm to a Game Official in any manner or attempting to do so.
(Note) Any game official assessing a gross misconduct penalty under Rule 601(g)1 shall file with the USA Hockey National Junior Referee-in-Chief or his designee a written game report within 12 hours of the incident.
 2. Deliberately injuring an opposing Team Official in any manner or attempting to do so.
 3. Behaving in any manner which is critically detrimental to the conducting of the game, including spitting at an opponent, spectator, game or team official, or verbally threatening a Game Official with physical harm.
(Note) Actual injury under (g.1 or g.2), is a Gross Misconduct II penalty.
- (h) If any Team Official is guilty of any one of the following, his team shall be assessed a bench minor penalty:
1. Banging the boards with a stick or other instrument at any time.
 2. Using obscene, profane, or abusive language or abusive gestures (including taunting) to any person or using the name of any Official coupled with any vociferous remarks.
 3. Throwing anything into the playing area from the vicinity of the players' bench during the game or during a stoppage of play.
 4. Using threatening or abusive language or gestures or similar actions designed to incite an opponent into incurring a penalty.
 5. Interfering in any non-physical manner with any Game Official including the Referee, Linesman, Timekeepers or Goal Judges in the performance of their duties.
- (i) If any Team Official is guilty of any of the following, he shall be assessed a game ejection and/or game misconduct penalty, and may be subject to a fine. A Team Official incurring a Game Ejection penalty shall be subject to a fine no to exceed five hundred dollars (\$500). A Team Official incurring a Game Misconduct penalty shall be subject to a fine not to exceed seven hundred fifty dollars (\$750):
1. Using obscene gestures, or racial/ethnic slurs, on the ice or anywhere in the rink before, during or after the game.
 2. Persisting in any course of conduct for which he has previously been assessed a bench minor penalty.
 3. Interfering in any physical manner with any Game Official including the Referee, Linesman, Timekeepers or Goal Judges in the performance of their duties.
 4. Who by way of his actions or demeanor threatens harm or threatens injury to a member of the opposing team or a Game Official.
- (j) If any Team Official is guilty of any one of the following, he shall be assessed a gross misconduct penalty:
1. Deliberately inflicting physical harm to a game official in any manner or attempting to do so.
(Note) Any game official assessing a gross misconduct penalty under Rule 601(j)1 shall file with the USA Hockey National Junior Referee-in-Chief or his designee a written game report within 12 hours of the incident.
 2. Deliberately injuring a player or Team Official in any manner or attempting to do so.
 3. Behaving in any manner which is critically detrimental to the conducting of the game, including spitting at an opponent, spectator, game or team official, or verbally threatening a Game Official with physical harm.
(Note) Actual injury under (j.1 or j.2), is a Gross Misconduct II penalty. In addition, the Team Official may be subject to a fine not to exceed one thousand five hundred dollars (\$1,500) for a Gross Misconduct or two thousand five hundred dollars (\$2,500) for a Gross Misconduct II.

Rule 602. Adjustment to Clothing and Equipment

- (a) Play shall not be stopped, nor the game delayed by reason of adjustment to clothing, equipment, skates or sticks. For an infringement of this rule, a minor penalty shall be assessed.
- (b) The onus of maintaining clothing and equipment in proper condition shall be upon the player and the team. If adjustments are required, the player shall retire from the ice and play shall continue uninterrupted with a substitute.
- (c) No delay shall be permitted for the repair or adjustment of goalkeeper's equipment. If adjustments are required the goalkeeper will retire from the ice and his place will be taken by the substitute or temporary goalkeeper (See Glossary) immediately and no warm-up will be permitted unless the team uses its time-out. For an infraction of this rule by a goalkeeper, a minor penalty shall be imposed.

Rule 603. Attempt to Injure / Deliberate Injury of Opponents (Head Butting)

- (a) A match penalty shall be imposed on any player who deliberately injures or attempts to injure an opponent and the circumstances shall be reported to the proper authorities for further action. A substitute for the penalized player shall be permitted at the end of the fifth minute.
- (b) A gross misconduct shall be imposed on any player or Team Official who deliberately injures or attempts to injure a Team Official or Game Official in any manner and the circumstances shall be reported to the proper authorities for further action.
- (c) Any player wearing tape or any other material on his hands who cuts or injures an opponent during an altercation shall receive a match penalty under this rule.
- (d) A double minor plus game ejection penalty or a major plus game misconduct penalty shall be imposed on any player who "head-butts" in such a manner as to in any way foul an opponent.

(Note) "Head-butting" may also be treated as an Attempt to Injure or Deliberate Injury of an Opponent under Rule 603.

Rule 604. Board-Checking

- (a) A minor or a major penalty, at the discretion of the Referee based upon the degree of violence of the impact with the boards, shall be imposed on any player who body-checks, cross-checks, elbows, charges or trips an opponent in such a manner that causes the opponent to be thrown violently into the boards.

(Note) Any unnecessary contact with a player playing the puck on an obvious "icing" or "off-side" play which results in that player being knocked into the boards is "boarding" and must be penalized as such. In other instances where there is no contact with the boards it should be treated as "charging".

"Rolling" an opponent (if he is the puck carrier) along the boards where he is endeavoring to go through too small an opening is not boarding. However, if the opponent is not the puck carrier, then such action should be penalized as boarding, charging, interference or if the arms or sticks are employed it should be called holding or hooking.

- (b) When a player injures an opponent as the result of "boarding," the Referee shall have no alternative but to impose a major plus game ejection penalty or a major plus game misconduct penalty on the offending player.
- (c) During an icing situation, any player who makes unnecessary contact with an opponent shall be assessed a minor or major penalty plus a game ejection/game misconduct penalty. This may also be treated under Rule 603 (Attempt to Injure or Deliberate Injury of Opponents).

Rule 605. Broken Stick

- (a) A player or goalkeeper without a stick may participate in the game. A player or goalkeeper whose stick is broken may participate in the game provided he drops the stick. A minor penalty shall be imposed for an infraction of this rule.

(Note) A broken stick is one which, in the opinion of the Referee, is unfit for normal play.

- (b) A replacement for a stick which is either broken or no longer in possession of a player or goalkeeper may only be obtained from the players' bench or a teammate on the ice. For a violation of this rule a bench minor penalty shall be assessed to the team of the player receiving the replacement stick provided that no penalty is assessed under Rule 601(c.2) or (h.3) for this infraction.

The team, a member of which throws a replacement stick into the playing area, must be penalized under Rule 601(c.2) or (h.3), Throwing Articles into the Playing Area. A player receiving a stick so thrown shall not be penalized.

(Note) The intent of this rule is to provide for the assessment of one penalty for any one illegal stick replacement.

- (c) A goalkeeper whose stick is broken may not go to the players' bench for a replacement during a stoppage of play, but must receive his stick from a teammate.

For an infraction of this rule a minor penalty shall be imposed on the goalkeeper.

Rule 606. Charging

- (a) A minor or a major penalty shall be imposed on a player who runs or jumps into or charges an opponent.

(Note) If more than two steps or strides are taken, it shall be considered "charging".

When a player injures an opponent as the result of "Charging" the Referee shall have no alternative but to impose a major plus game ejection penalty or a major plus game misconduct penalty on the offending player.

- (b) A minor or a major penalty shall be imposed on a player who body checks or charges a goalkeeper while the goalkeeper is within his goal crease or privileged area.

A goalkeeper is NOT "fair game" just because he is outside his privileged area. A penalty for interference or charging should be called in every case where an opposing player makes unnecessary contact with a goalkeeper.

Likewise, Referees should be alert to penalize goalkeepers for tripping, slashing, or spearing in the vicinity of the goal.

Rule 607. Checking from Behind

- (a) A minor penalty, minor plus misconduct penalty, double minor plus game ejection penalty, or major plus game misconduct penalty shall be imposed on any player who body checks or pushes an opponent from behind, or who body checks or pushes an opponent from behind head first into the side boards, end boards or goal frame.

When a player injures an opponent as the result of "Checking from Behind" the Referee shall have no alternative but to impose a major plus a game misconduct penalty on the offending player.

(Note) Checking from behind may also be treated as Attempt to Injure or Deliberate Injury of an Opponent under Rule 603.

- (b) A player who is assessed a second major and Game Misconduct penalty for checking from behind in the same season shall be suspended for an additional two games. This suspension shall double in length for each additional checking from behind major and Game Misconduct penalty assessed to the player during the same season. This suspension is in addition to any other suspensions imposed.
- (c) If injury to the opponent results under sub-sections (a) or (b) of this rule, a major plus game misconduct penalty is required.

Rule 608. Cross-Checking or Butt-Ending

- (a) A minor or a major penalty shall be imposed on a player who "cross-checks" an opponent.

(Note) "Cross-check" shall mean a check delivered with both hands on the stick and no part of the stick on the ice.

- (b) A major plus game ejection penalty or a major plus game misconduct penalty shall be imposed on any player who injures an opponent by "cross-checking".
- (c) A minor plus misconduct penalty or a double minor plus game ejection penalty or major plus game misconduct penalty shall be imposed on any player who "butt-ends" or attempts to "butt-end" an opponent. The minor plus misconduct penalty option may only be assessed for an attempted butt-end where no contact with the opponent is made.

(Note 1) Attempt to “butt-end” shall include all cases where a “butt-end” gesture is made regardless of whether body contact is made or not.

(Note 2) “Butt-ending” may also be treated as an Attempt to Injure or Deliberate Injury of an Opponent under Rule 603.

Rule 609. Delaying the Game

- (a) A minor penalty shall be imposed on any player or goalkeeper who delays the game by deliberately shooting or batting the puck with his stick outside the playing area.

(Note) This penalty shall apply also when a player or goalkeeper deliberately bats or shoots the puck with his stick outside the playing area after a stoppage of play.

- (b) A minor penalty shall be imposed on a goalkeeper who shoots the puck directly (non-deflected) outside of the playing area, except that no penalty shall apply if the puck inadvertently leaves the playing area in a location which is not protected by glass or screen.
- (c) A minor penalty shall be imposed on any player (including a goalkeeper) who delays the game by deliberately displacing a goal post from its normal position. The Referee or Linesmen shall stop play immediately when a goal post has been displaced.

If the defending team has deliberately displaced the goal post, thereby depriving the attacking team of an immediate and reasonable scoring opportunity, or if, during the course of a break-away the goalkeeper deliberately removes his helmet/facemask, a penalty shot/optional minor penalty shall be awarded to the non-offending team, which shot shall be taken by the player last in possession of the puck.

If a player of the defending team deliberately displaces the goal, and, in the opinion of the Referee, the puck would have entered the goal had it not been displaced, or if the defending team deliberately displaces the goal when the goalkeeper is off the ice, thereby preventing an obvious and imminent goal, a goal shall be awarded in lieu of a penalty shot.

(Note) A player with a “break-away” is defined as a player in control of the puck with no opposition between the player and the opposing goal and with a reasonable scoring opportunity.

If a minor penalty for deliberately displacing a goal, or for the goalkeeper deliberately removing his helmet/facemask during play, is assessed with less than two minutes remaining in regulation time, or at any time during overtime, a penalty shot/optional minor shall be assessed against the offending team in lieu of the minor penalty.

- (d) A bench minor penalty shall be imposed upon any team which, after warning by the Referee to its Captain to place the correct number of players on the ice and commence play, fails to comply with the Referee’s direction and thereby causes any delay by making additional substitutions, by persisting in having its players off-side, including failure to line up properly for a face-off under Rule 611(a) or in any other manner.
- (e) A minor penalty shall be imposed on a player or goalkeeper who deliberately holds the puck against the boards, goal or ice with his stick, skate, foot or any other part of his body for the purpose of delaying the game (see Rule 612(b), Falling on the Puck).

A minor penalty shall be imposed on a goalkeeper who has an opportunity to play the puck with his stick prior to being pressured by an attacking player, but instead causes a stoppage of play.

- (f) A minor penalty for delaying the game shall be assessed to a player who, after a warning by the Referee, fails to maintain a proper position during the conducting of a face-off.
- (g) If opposing players gather after a stoppage of play and do not immediately proceed to the face-off location or their respective players’ benches, they shall be assessed coincidental minor penalties for delay of game. After the third set of coincidental minor penalties are assessed to players under this rule and after a warning is issued to the both benches, subsequent players are assessed Misconduct penalties.

Rule 610. Elbowing or Kneeing

- (a) A minor or a major penalty shall be imposed on any player who uses his elbow or knee in such a manner as to in any way foul an opponent.
- (b) A major plus game ejection or a major plus game misconduct penalty shall be imposed on any player who injures an opponent as the result of a foul committed by elbowing or kneeling.

Rule 611. Face-Offs

- (a) The puck shall be “faced-off” by the Referee or the Linesman dropping the puck on the ice between the sticks of the players “facing-off.” Players facing-off will stand squarely facing their opponents’ end of the rink approximately one stick length apart with the blade of their sticks touching the ice. The attacking team player shall be the first player to place his stick on the ice. For face-offs along the center red line, the visiting team player shall place his stick on the ice first.

When the face-off takes place at any of the end face-off spots, the players taking part shall be stationary and stand squarely facing their opponents’ end of the rink, and clear of the ice markings. The sticks of both players facing-off shall have the blade on the ice in contact with the nearest white area of the face-off spot and clear of the red center area of the spot.

No other player shall be allowed to enter the face-off circle or come within 15 feet of the players facing-off the puck, and must stand on-side on all face-offs.

If a player, other than the player facing off, fails to maintain his proper position, the center of his team shall be ejected from the face-off.

At the conclusion of the line change procedure, the Official conducting the face-off shall blow his whistle. This will signal each team that they have no more than 5 seconds to line up for the ensuing face-off. Prior to the conclusion of 5 seconds, the Official shall conduct a proper face-off. If any player, other than the players facing off, fails to maintain his proper position, the center of his team shall be ejected from the face-off.

- (b) A second violation of any of the provisions of subsection (a) hereof by the same team during the same face-off shall be penalized with a minor penalty to the player who commits the second violation of the rule.
- (c) If, after a warning by the Referee or Linesman, either of the players fails to take his proper position for the face-off within 5 seconds, the Official shall be entitled to face-off the puck notwithstanding such default.
- (d) In the conduct of any face-off anywhere on the playing surface, no player facing-off shall make any physical contact with his opponent’s body by means of his own body or by his stick except in the course of playing the puck after the face-off has been completed.

For violation of this rule the Referee shall impose a minor penalty or penalties on the player(s) whose action(s) caused the physical contact.

(Note) “Conduct of any face-off” commences when the On-Ice Official designates the place of the face-off and he takes up his position to drop the puck.

- (e) If a player facing-off fails to take his proper position immediately when directed by the Official, the Official may order him replaced for that face-off by any teammate then on the ice.

No substitution of players shall be permitted until the face-off has been completed and play has been resumed except when any penalty is imposed.

- (f) When an infringement of a rule has been committed or a stoppage of play has been caused by any player of the attacking team in the Attacking Zone the ensuing face-off shall be made in the Neutral Zone on the nearest face-off spot.

(Note) This includes a stoppage of play caused by a player of the attacking team shooting the puck onto the back of the defending team’s goal without any intervening action by the defending team.

- (g) When an infringement of a rule has been committed by players of both teams in the play, resulting in a stoppage, or when the game is stopped for any reason not specifically covered in these official rules, the puck must be faced off at the nearest point along the imaginary lines on each side connecting the end zone face-off spots to where the puck was last played.

When an infringement of a rule causes a stoppage of play and the offending team gains a territorial advantage, the ensuing face-off shall be conducted where the stoppage of play occurred.

- (h) When a stoppage occurs between the end face-off spots and near end of the rink, the puck shall be faced-off at the end face-off spot on the side where the stoppage occurs, unless otherwise expressly provided by these rules.
- (i) When a goal is legally scored the ensuing face-off shall be conducted at center ice. When a goal is illegally scored as a result of a puck being deflected directly from an Official anywhere in the Defending Zone, the resulting face-off shall be made at the end face-off spot in the Defending Zone.

- (j) The whistle will not be blown to start play. Playing time will commence from the instant the puck is faced-off and will stop when the whistle is blown.
- (k) When a stoppage of play in an end zone takes place and is followed by a gathering of players, no attacking player shall enter the end zone further than the outer edge of the face-off circles nearest the blue line (this includes players on the ice at the time of the stoppage of play, or players involved in a line change).

For a violation of this rule the ensuing face-off shall take place at the nearest Neutral Zone face-off spot.

Rule 612. Falling on Puck

- (a) A minor penalty shall be imposed on a player other than the goalkeeper who deliberately falls on or gathers the puck into his body.

(Note) Any player who drops to his knees to block a shot should not be penalized if the puck is shot under him or becomes lodged in his clothing or equipment, but any use of the hands to make the puck unplayable should be penalized promptly.

- (b) A minor penalty shall be imposed on a goalkeeper who deliberately falls on or gathers the puck into his body, when his body is entirely outside the boundaries of the goal crease and the puck is behind the goal line or when the puck is outside the boundaries of the “goalkeeper’s privileged area,” or who holds or places the puck against any part of the goal or against the boards, or when provided an opportunity to play the puck with his stick prior to being pressured by an attacking player (See also Rule 609(e), Delaying the Game).
- (c) No defending player, except the goalkeeper, shall be permitted to fall on the puck or hold the puck or gather the puck into the body or hands when the puck is within the goal crease.

For infringement of this rule, play shall immediately be stopped and a penalty shot/optional minor shall be awarded to the non-offending team. No other penalty shall be assessed; However, if the goalkeeper has been removed from the ice when the infraction occurs, a goal shall be awarded to the non-offending team and no penalty shot shall be awarded, if the action of the offending player prevents an obvious and imminent goal.

(Note) This rule shall be interpreted so that a penalty shot/optional minor will be awarded only when the puck is in the crease at the instant the infraction occurs. However, in cases where the puck is outside the crease, Rule 612(a) may still apply and a minor penalty may be imposed, even though no penalty shot is awarded.

Rule 613. Fisticuffs (Fighting)

(Note) An instigator of an altercation shall be a player who by his actions or demeanor demonstrates any or some of the following criteria: distance traveled; gloves off first; first punch thrown; menacing attitude or posture; verbal instigation or threats; conduct in retaliation to a prior game incident.

- (a) A major penalty shall be imposed on any player who engages in fisticuffs. An additional minor penalty plus a game ejection/game misconduct shall be imposed on any player who starts or instigates fisticuffs. A player who is assessed a major and game ejection for being an instigator/aggressor of an altercation will have on his record as being an instigator of an altercation for statistical and suspension purposes. A player who is assessed two game ejections/game misconducts for instigating fisticuffs shall be suspended for one additional game. This suspension shall increase with every two instigator penalties by one game. A player penalized as an instigator of an altercation who is wearing greater facial protection than his opponent shall be assessed an additional minor penalty for unsportsmanlike conduct.
- (b) A minor penalty shall be imposed on a player who, having been struck, shall retaliate with a blow or attempted blow. However, at the discretion of the Referee a double minor or a major penalty may be imposed if such player continues the altercation.

(Note 1) The Referee is provided very wide latitude in the penalties which he may impose under this rule. This is done intentionally to enable him to differentiate between the obvious degrees of responsibility of the participants either for starting the fighting or persisting in continuing the fighting. The discretion provided shall be exercised realistically.

(Note 2) Referees are directed to employ every means provided by these rules to stop “brawling” and should use Rule 601(e.2) “Abuse of Officials and Other Misconduct” for this purpose.

- (c) A major penalty shall be imposed on any player involved in fisticuffs off the playing surface or with another player who is off the playing surface before, during or after the game. A player involved in fisticuffs under this section shall be assessed a game misconduct penalty and shall be suspended for the next two games and

may be subject to further discipline/suspensions. A team whose player(s) are involved in fisticuffs under this section may also be assessed further fines/suspensions.

- (d) A game ejection penalty, whether before or after the five minute remaining mark of the third period or any part of overtime, shall be imposed on any player or goalkeeper who is the first to intervene in an altercation then in progress. This penalty is in addition to any other penalty incurred in the same incident.
- (e) Any player receiving a major penalty for fisticuffs shall be ruled off the ice for five minutes, during which time no substitute shall be permitted. A player who receives a second major penalty for fighting in the same game shall be assessed a game ejection penalty under this section. During the regular season or playoffs, any player or goalkeeper who receives a major penalty for fighting with less than five minutes remaining in regulation time or anytime during overtime shall be assessed a game misconduct penalty which carries an automatic suspension for the next two scheduled games. For pre-season or exhibition games, any player or goalkeeper who receives a major penalty for fighting with less than five minutes remaining in the third period or in any part of overtime shall be assessed a game misconduct penalty which carries an automatic suspension for the next scheduled game. When fisticuffs occur with less than five minutes remaining in the third period or in any part of overtime and an instigator penalty is assessed, the Referee shall waive any automatic game ejection/game misconduct penalties and assess a misconduct penalty to the non-offending player in lieu of the automatic game ejection or game misconduct penalty.
- (f) When an altercation occurs on the ice, at the signal of the Referee, all players (non-participant), excluding goalkeepers, must proceed immediately and directly to their respective players' bench. Goalkeepers must remain in the immediate vicinity of their goal crease. See Rule 407(d) (Goalkeeper's Penalties). The Referee shall report to the League any player who does not immediately proceed to his players' bench when ordered to do so. Failure of a player to immediately report to the players' bench will result in a one hundred dollar (\$100) fine per occurrence plus twenty five dollars (\$25) per player.

A minor penalty shall be imposed on any player, including a goalkeeper, who removes his glove or gloves and/or drops his stick during an altercation and who is not a participant in the original altercation. A game misconduct penalty may be added to the minor penalty if, in the judgment of the Referee, the player is the instigator of a subsequent altercation. This penalty shall be in addition to any other penalty incurred in the same incident.

- (g) A game misconduct penalty shall be imposed on any player who is assessed a major penalty following the original fight/fisticuffs. Notwithstanding this rule, at the discretion of the Referee the automatic game misconduct may be waived and a game ejection may be assessed if the opposing player was clearly the instigator of the altercation. Any player(s) who engages in fisticuffs during a line change and prior to the ensuing face-off shall receive an automatic game ejection/game misconduct penalty.
- (h) Any team whose players become involved in an altercation other than during the periods of the game may be fined up to two thousand dollars (\$2,000), in addition to any appropriate penalty and other fines that may be imposed upon the participating player(s) by supplementary discipline or otherwise.
- (i) Any player who would be deemed to be involved in any post/pre-game altercation or post/pre-game altercation and is assessed a game misconduct shall be suspended for the next two games and may face further suspension.

(Note) In the case of an altercation taking place before the start/after the period/game, the fine(s) and/or suspensions under this rule shall be assessed only in the event that an altercation commences before the period has started or after the period has terminated.

- (j) A player who deliberately removes any equipment other than his stick, gloves and helmet during an altercation shall receive an automatic game ejection/game misconduct penalty in addition to any other penalties incurred.

Rule 614. Goals and Assists

(Note) It is the responsibility of the Referee to award goals and assists, and his decision in this respect is final. Such awards shall be made or withheld strictly in accordance with the provisions of this rule. Therefore, it is essential that the Referee shall be thoroughly familiar with every aspect of this rule, be alert to observe all actions which could affect the making of an award and, above all, the awards must be made or withheld with absolute impartiality.

In cases of an obvious error in awarding a goal or an assist which has been announced, it should be corrected promptly. Changes shall not be made in the official scoring summary after the Referee has signed the Game Report.

- (a) A goal shall be scored when the puck shall have been put between the goal posts by the stick of a player of the attacking team, from in front, and below the cross bar, and entirely across the goal line.
- (b) A goal shall be scored if the puck is put into the goal in any way by a player of the defending team. The player of the attacking team who last played the puck shall be credited with the goal but no assist shall be awarded.
- (c) If an attacking player kicks the puck, using a distinct kicking motion, and the puck goes directly into the goal or is deflected into the goal by any player, including the goalkeeper, a goal shall not be allowed.
- (d) If the puck shall have been deflected into the goal from the shot of an attacking player by striking any part of a player of the same team, a goal shall be allowed. The player who deflected the puck shall be credited with the goal. The goal shall not be allowed if the puck has been thrown or otherwise deliberately directed into the goal by any means other than a stick. However, if the puck should enter the goal off a skate of an attacking player, the goal shall be allowed as long as there was no distinct kicking motion.
- (e) If a goal is scored as a result of a puck being deflected directly into the goal from an Official, the goal shall not be allowed.
- (f) Should a player legally propel a puck into the goal crease of the opposing team and the puck should become loose and available to another player of the attacking team, a goal scored on the play shall be valid.
- (g) Any goal scored, other than as covered by the official rules, shall not be allowed.
- (h) A “goal” shall be credited in the scoring records to a player who shall have propelled the puck into the opponents’ goal. Each “goal” shall count one point in the player’s record.
- (i) When a player scores a goal, an “assist” shall be credited to the player or players taking part in the play immediately preceding the goal, but not more than two assists can be given on any goal. Each “assist” so credited shall count one point in the player’s record.
- (j) Only one point can be credited to any one player on a goal.

Rule 615. Handling Puck With Hands

- (a) If a player, except a goalkeeper, closes his hand on the puck, play shall be stopped and a face-off shall follow; however, if the puck is dropped to the ice immediately, play shall not be stopped.

If a goalkeeper holds the puck with his hand for more than three seconds, play shall be stopped and a face-off shall follow; however, after an initial warning by the Referee, a goalkeeper who holds the puck unnecessarily shall be assessed a minor penalty for delay of game.

- (b) A goalkeeper shall not drop the puck into his pads or onto the goal net, nor deliberately pile up snow or obstacles at or near his goal that, in the opinion of the Referee, would tend to prevent the scoring of a goal. The penalty for infringement of this rule by the goalkeeper shall be a minor penalty.

(Note 1) The object of this rule is to keep the puck in play continuously and any action taken by the goalkeeper which causes an unnecessary stoppage must be penalized.

(Note 2) The goalkeeper may not leave his stick or part thereof in front of his goal. If he does and if the puck hits the stick thereby preventing an obvious and imminent goal while the goalkeeper is on the ice, but in the act of leaving the ice, or off the ice, the Referee shall stop play and award a goal to the non-offending team. See Rule 621(f), Interference.

- (c) If a goalkeeper catches the puck and throws it forward towards his opponent’s goal and it is first played by a teammate, play shall be stopped and the ensuing face-off shall be held at the nearest end face-off spot of the offending team. See also Rule 615(e).
- (d) A minor penalty shall be imposed on a player except the goalkeeper who, while play is in progress, picks up the puck off the ice with his hand.

If a defending player, except the goalkeeper, while play is in progress, picks up the puck with his hand from the ice in the goal crease, or holds the puck while the puck is in the goal crease, the play shall be stopped immediately and a penalty shot/optional minor shall be awarded to the non-offending team.

If a defending player picks up the puck from the goal crease or falls on or covers the puck in the crease thereby preventing an obvious and imminent goal when the goalkeeper has been removed from the ice, a goal shall be awarded to the non-offending team.

- (e) A player or goalkeeper shall be permitted to stop or “bat” the puck in the air with his hand or push it along the ice with his hand and play shall not be stopped unless he has directed the puck to a teammate in any zone other than his Defending Zone, in which case play shall be stopped and the puck faced-off at the spot where the offense occurred unless otherwise provided by these rules.

(Note) No territorial ice advantage can be gained from a team batting the puck with the hand.

A goal shall not be allowed if the puck was propelled by the hand of an attacking player and entered the goal either directly or after deflecting off any player including the goalkeeper.

Rule 616. Gross Misconduct

- (a) A Gross Misconduct penalty involves the suspension of a player or Team Official for the balance of the game, but another player is permitted to immediately replace a player so removed.
- (b) There shall be two classifications under this rule - Gross Misconduct and Gross Misconduct II. A player or Team Official incurring a Gross Misconduct penalty shall be suspended for the next scheduled League game, and for the next three scheduled League games for a Gross Misconduct II. In either case, said player or Team Official may be subject to further suspension following a mandatory hearing with the proper league authorities.

Rule 617. High Sticks

- (a) The carrying of sticks above the normal height of the shoulder is prohibited. A player is permitted accidental contact on an opponent if the act is committed as a normal wind-up or follow-through of a slap shot motion. The Referee may assess a minor or major penalty on any player violating this rule.
- (b) When a player carries or holds any part of his stick above the height of his shoulder so that injury to the opposing player results, the Referee shall have no alternative but to assess one of the following:
 - 1. A double minor penalty when deemed to be accidental in nature.
 - 2. A major plus a game ejection/misconduct penalty when it is deemed to be careless.
- (c) A goal scored from a stick so carried shall not be allowed, except by a player of the defending team.
- (d) Batting the puck above the normal height of the shoulders with the stick is prohibited and when it occurs there shall be a whistle and the ensuing face-off shall take place at one of the end face-off spots adjacent to the goal of the team causing the stoppage unless:
 - 1. The puck is batted to an opponent and the opponent gains possession and control of the puck in which case the play shall continue, or
 - 2. A player of the defending team shall bat the puck into his own goal in which case the goal shall be allowed.

(Note) When a player bats the puck to an opponent under sub-section 1, the Referee shall give the “wash-out” signal immediately. Otherwise he will stop the play.

Rule 618. Holding an Opponent

- (a) A minor penalty shall be imposed on a player who holds an opponent with hands or stick or in any other way.
- (b) A minor penalty, major plus game ejection penalty or a major plus game misconduct penalty shall be imposed on a player who grabs or holds the facemask of an opponent with his hand.

Rule 619. Hooking

- (a) A minor or major penalty shall be imposed on a player who impedes or seeks to impede the progress of an opponent by “hooking” with his stick.
- (b) A major plus game ejection penalty or a major plus game misconduct penalty shall be imposed on any player who injures an opponent by “hooking”.

Rule 620. Icing the Puck

- (a) For the purpose of this rule, the center line will divide the ice into halves. Should any player of a team, equal or superior in numerical strength to the opposing team, shoot, bat with the hand or stick, kick or deflect the puck from his own half of the ice, beyond the goal line of the opposing team, play shall be stopped and the puck faced off at the end face-off spot of the offending team. If the puck shall have entered the goal of the opposing team, after being legally shot, batted with the stick or deflected, the goal shall be allowed.

For the purpose of this rule, the point of last contact with the puck by the team in possession shall be used to determine whether icing has occurred or not.

(Note 1) If, during the period of a delayed whistle due to a foul by a player of the side NOT in possession, the side in possession “ices” the puck then the face-off following the stoppage of play shall take place in the Neutral Zone near the defending blue line of the team “icing” the puck.

(Note 2) When a team is “Shorthanded” as the result of a penalty and the penalty is about to expire, the decision as to whether there has been an “icing” shall be determined at the instant the penalty expires, and if the puck is shot before the penalty expires, icing shall not be called. The action of the penalized player remaining in the penalty bench will not alter the ruling.

(Note 3) For the purpose of interpretation of this rule, “Icing the Puck” is completed the instant the puck is touched first by a defending player other than the goalkeeper after it has crossed the goal line, and if in the action of so touching the puck it is knocked or deflected into the goal it is NO goal.

(Note 4) When the puck is shot and rebounds from the body or stick of an opponent in his own half of the ice so as to cross the goal line of the player shooting it, “icing” shall not be called.

(Note 5) Notwithstanding the provisions of this section concerning “batting” the puck in respect to the “icing the puck” rule, the provisions of the second paragraph of Rule 615(e) “Handling Puck With Hands”, apply and NO goal can be scored by batting the puck with the hand into the opponent’s goal, whether intended or not.

(Note 6) If, while the Linesman has signaled a slow whistle for a clean interception under Rule 626(d), “Off-Sides”, the player intercepting shoots or bats the puck beyond the opponent’s goal line in such a manner as to constitute “icing the puck”, the Linesman’s “slow whistle” shall be considered exhausted the instant the puck crosses the blue line and icing shall be called in the usual manner.

- (b) If the puck was so shot by a player of a team below the numerical on-ice strength of the opposing team, play shall continue and the face-off shall not take place.
- (c) If, however, the puck shall go beyond the goal line in the opposite half of the ice directly from either of the players while facing-off, it shall not be considered a violation of this rule.
- (d) If, in the opinion of the Linesman, a player of the opposing team excepting the goalkeeper is able to play the puck before it passes the goal line, but has not done so, icing shall not be called and play shall continue. Should the opposing goalkeeper leave his crease and/or feign playing the puck during a potential icing situation, icing shall not be called and play shall be allowed to continue.

(Note) The purpose of this section is to enforce continuous action and the On-Ice Officials should interpret and apply the rule to produce this result.

- (e) If the puck shall touch any part of a player of the opposing team or his skates or his stick before it shall have reached the goal line, or shall have touched the goalkeeper or his skates or his stick at any time before crossing his goal line, it shall not be considered as “icing the puck” and play shall continue.
- (f) If the Linesman shall have erred in calling an “icing the puck” infraction (regardless of whether either team is shorthanded) a last play face-off (nearest end zone face-off spot) shall occur.

Rule 621. Interference

- (a) A minor penalty shall be imposed on a player who interferes with or impedes the progress of an opponent who is not in possession of the puck, or who deliberately knocks a stick out of an opponent’s hand or who prevents a player who has dropped his stick or any other piece of equipment from regaining possession of it or who knocks or shoots any abandoned or broken stick or illegal puck or other debris towards an opposing puck carrier in a manner that could cause him to be distracted. (See also Rule 636, Throwing Stick.)

(Note) The last player to touch the puck, other than a goalkeeper, shall be considered the player in possession. In interpreting this rule the Referee should make sure which of the players is the one creating the interference.

Often it is the action and movement of the attacking player which causes the interference since the defending players are entitled to “stand their ground” or “shadow” the attacking player. Players of the side in possession shall not be allowed to “run” deliberate interference for the puck carrier.

- (b) A minor penalty shall be imposed on any player on the players’ bench or on the penalty bench who by means of his stick or his body interferes with the movements of the puck or of any opponent on the ice during the progress of play.
- (c) A minor penalty shall be imposed on a player who, by means of his stick or his body, interferes with or impedes the movements of the goalkeeper by actual physical contact, while he is in his goal crease unless the puck is already in the crease.
- (d) When the puck is in the Attacking Zone and not in the goal crease, a player of the attacking team may not stand on the goal crease line or in the goal crease, hold his stick in the goal crease or skate through the goal crease. If the puck should enter the goal while such a condition prevails, a goal shall not be allowed. For violation of this rule, while the attacking team has possession of the puck, play shall be stopped and a face-off held at the nearest Neutral Zone face-off spot.

(Note) This rule shall not apply when the goalkeeper is out of his goal crease.

- (e) If a player of the attacking team has been physically interfered with by the action of any defending player so as to cause him to be in the goal crease, and the puck should enter the goal while the player so interfered with is still within the goal crease, the “goal” shall be allowed.
- (f) When a player in control of the puck on the opponent’s side of the center red line, and having no opponent to pass other than the goalkeeper, is interfered with by a stick or part thereof or any other object thrown or shot by any member of the defending team including any Team Official, a penalty shot/optional minor shall be awarded to the non-offending team.

(Note) The attention of Referees is directed particularly to three types of offensive interference which should be penalized:

1. When the defending team secures possession of the puck in its own end and the other players of that team run interference for the puck carrier by forming a protective screen against forecheckers;
2. When a player facing-off obstructs his opponent after the face-off when the opponent is not in possession of the puck;
3. When the puck carrier makes a drop pass and follows through so as to make bodily contact with an opposing player.

Defensive interference consists of bodily contact with an opposing player who is not in possession of the puck.

Rule 622. Interference by Spectators

- (a) In the event of a player being held or interfered with by a spectator, the Referee or Linesman shall blow the whistle and play shall be stopped, unless the team of the player interfered with is in possession of the puck at the time, in which case the play shall be allowed to be completed before blowing the whistle, and the puck shall be faced at the spot where last played at the time of stoppage.

(Note) The Referee shall report to the proper authorities for disciplinary action all cases in which a player becomes involved in an altercation with a spectator.

- (b) Any player who physically interferes with a spectator shall be assessed a game misconduct penalty and the Referee shall report all such infractions to the proper authorities who shall have full power to impose such further penalty as deemed appropriate.
- (c) In the event that objects are thrown on the ice which interfere with the progress of the game, the Referee shall blow the whistle and stop the play, and the puck shall be faced-off at the spot where play is stopped.

Rule 623. Kicking Player

- (a) A major plus a game misconduct penalty shall be imposed on any player or goalkeeper who uses their skate to “push off” an opponent. Any kicking motion by a player or goalkeeper must be penalized under subsection (b) below.
- (b) A Match penalty shall be imposed on any player who kicks or attempts to kick another player. If a player or goalkeeper injures an opponent by kicking, a Match penalty shall be assessed.

Rule 624. Kicking Puck

- (a) Kicking the puck shall be permitted in all zones; however, a goal shall not be allowed if the puck was kicked, using a distinct kicking motion, by an attacking player and entered the goal either directly or after deflecting off any player including the goalkeeper.

Rule 625. Leaving the Players’ Bench or Penalty Bench

- (a) No player may leave the players’ bench or penalty bench at any time during an altercation or for the purpose of starting an altercation. Substitutions made prior to the altercation shall not be penalized under this rule provided the players so substituting do not enter the altercation.
- (b) For violation of this rule, a major plus a game misconduct penalty, up to a maximum of five per team, shall be imposed on any player who leaves the players’ bench or penalty bench during an altercation.

In addition, any team whose players leave the players’ bench or penalty bench during an altercation may be subject to a fine not to exceed one thousand dollars (\$1,000) per occurrence per team and may also be subject to a fine of up to two hundred fifty dollars (\$250) per player involved (up to a maximum of five per team).

Any player who incurs a second penalty under this sub-section in the same season shall be suspended automatically for the next two games of his team. For each subsequent violation in the same season, the automatic suspension shall be increased by one game. In Play-Off games, any player who incurs a penalty under this sub-section shall be suspended automatically for the next Play-Off game of his team. For each subsequent violation, this automatic suspension shall be increased by one game. The automatic suspensions incurred under this sub-section in respect to regular season games shall have no effect with respect to violations during Play-Off games.

The first player of each team to leave the players’ or penalty bench during an altercation or for the purpose of starting fisticuffs whereby a subsequent fisticuffs occur, shall incur an automatic five game suspension. This penalty is in lieu of any other penalty he may be assessed. This penalty shall be doubled with each subsequent violation during the same season.

Any other players who are assessed a major and Game Misconduct penalty under this section shall incur an automatic two game suspension. This penalty shall be doubled with each subsequent violation.

In Playoff games, any player under this subsection shall be automatically suspended for one game if they leave the players’ or penalty bench during an altercation.

- (c) Except at the end of each period, or on expiration of a penalty, no player may at any time leave the penalty bench.
- (d) A penalized player who leaves the penalty bench before his penalty has expired, whether play is in progress or not, shall incur an additional minor penalty after serving his unexpired penalty.
- (e) If a player leaves the penalty bench before his penalty is fully served, the Penalty Timekeeper shall note the time and verbally alert the Referee who will stop play when the offending player’s team has or gains possession and control of the puck.
- (f) In the case of a player returning to the ice before his time has expired through an error of the Penalty Timekeeper, he is not to serve an additional penalty, but must serve his unexpired time.
- (g) If a player of an attacking team in possession of the puck shall be in such a position as to have no opposition between him and the opposing goalkeeper, and while in such a position he shall be interfered with by a player of the opposing team who shall have illegally entered the game, the Referee shall impose a penalty shot/optional minor against the offending player’s team.

- (h) If a Team Official gets on the ice after the start of a period and before that period is ended without the permission of the Referee, the Referee shall impose a bench minor penalty against the team or a game misconduct penalty on the individual or both and report the incident to the proper authorities. If any club executive or Manager gets on the ice after the start of a period and before that period is ended without the permission of the Referee, the offending team shall be subject to a fine up to three thousand dollars (\$3,000).
- (i) If a penalized player returns to the ice from the penalty bench before his penalty has expired by his own error or the error of the Penalty Timekeeper, any goal scored by his own team while he is illegally on the ice shall be disallowed, but all penalties imposed on either team shall be served as regular penalties.
- (j) If a player shall illegally enter the game from his own players' bench or from the penalty bench, any goal scored by his own team while he is illegally on the ice shall be disallowed, but all penalties imposed against either team shall be served as regular penalties.
- (k) If a team's player(s) leave the players or penalty bench during an altercation, the Coach and Assistant Coaches of the offending team may be suspended for up to three games for the first offense during a season. This suspension shall double with each subsequent violation during the same season. In addition, the Head Coach and Assistant Coaches may also be fined up to one thousand dollars (\$1,000) per occurrence. This fine is in addition to any other fines that may be assessed.

Rule 626. Off-Sides

- (a) Players of an attacking team may not precede the puck into the Attacking Zone.

(Note) A player actually propelling and in possession and control of the puck who shall cross the line ahead of the puck shall not be considered "off-side."
- (b) For a violation of this Rule, play shall be stopped and a face-off conducted.

If the puck was carried over the blue line at the time of the violation, the face-off shall take place at the nearest Neutral Zone face-off spot to where the puck crossed the line. If the puck was passed or shot over the blue line, the face-off shall take place where the pass or shot originated.
- (c) The position of the player's skates and not that of his stick shall be the determining factor in deciding an "off-side" violation. A player is off-side when both skates are completely over the outer edge of the blue line into his Attacking Zone.

(Note 1) A player is "on-side" when "either" of his skates are in contact with the Neutral Zone ice, or when the entire player, including both skates, is completely behind the determining edge of the blue line, at the instant the puck completely crosses the outer edge of that line, regardless of the position of his stick.

(Note 2) The position of the player's skates is what determines whether a player is "off-side". However, the question of "off-side" never arises until the puck has completely crossed the line into the Attacking Zone, at which time the decision is to be made.
- (d) If an attacking player precedes the puck which is shot, passed or deflected into the Attacking Zone, but a defending player is able to play the puck at or near the blue line, the Linesman shall signal a delayed off-side. The Linesman shall drop his arm to nullify the off-side violation and allow play to continue if the defending team passes or carries the puck into the Neutral Zone.

The off-side violation will also be nullified if all attacking players in the Attacking Zone clear the Attacking Zone by making skate contact with the blue line. The Attacking Zone must be completely clear of attacking players before a delayed off-side can be nullified with the puck still in the Attacking Zone.

During the delayed off-side, the Linesman shall stop play for the off-side violation if ANY attacking player touches the puck or attempts to gain possession of a loose puck while the puck is still in the Attacking Zone or forces the defending puck carrier further back in the Attacking Zone.
- (e) If a player legally carries or passes the puck back into his own Defending Zone while a player of the opposing team is in such Defending Zone, the "off-side" shall be waived and play permitted to continue. (No "delayed whistle.")
- (f) If, in the opinion of the Linesman, a player has intentionally caused an off-side play (including a puck shot on goal), the Linesman shall stop play immediately and the puck shall be faced-off at the nearest end zone face-off spot in the Defending Zone of the offending team.

(Note) An intentional off-side is one which is made for the purpose of deliberately securing an immediate stoppage of play, regardless of the reason, or where an off-side play is made under conditions where there is no possibility of completing a legal play.

- (g) If the Linesman shall have erred in stopping play for an off-side infraction the ensuing face-off shall take place at the nearest Neutral Zone face-off spot to the blue line where play was stopped in error.

Rule 627. Passes

- (a) The puck may be passed by any player to a player of the same side within any one of the three zones into which the ice is divided, but may not be passed forward from a player in one zone to a player of the same side in another zone, except by a player on the defending team, who may make and take forward passes from their own Defending Zone to the center line without incurring an offside violation. This pass, however, must be completed by a receiving player who is legally onside at the center line, or by a receiving player who is preceded by the puck across the center line, otherwise play shall be stopped and the face-off shall be conducted at the spot from which the pass originated.

(Note 1) The position of the puck (not the player's skates) shall be the determining factor in deciding from which zone the pass was made.

(Note 2) Passes may be completed legally at the center red line in exactly the same manner as passes at the attacking blue line.

- (b) Should the puck, having been passed, contact any part of the body, stick or skates of a player of the same team who is legally onside, the pass shall be considered to have been completed.
- (c) The player last touched by the puck shall be deemed to be in possession.
Rebounds off goalkeeper's pad or other equipment shall not be considered as a change of possession or the completion of the play by the team when applying Rule 409(b) (Calling of Penalties).
- (d) If a player in the Neutral Zone is preceded into the Attacking Zone by the puck passed from the Neutral Zone he shall be eligible to take possession of the puck anywhere in the Attacking Zone except when the "Icing the Puck" rule applies.
- (e) If a player in the same zone from which a pass is made is preceded by the puck into succeeding zones, he shall be eligible to take possession of the puck in that zone except where the "Icing the Puck" rule applies.
- (f) If an attacking player passes the puck backward toward his own goal from the Attacking Zone, an opponent may play the puck anywhere regardless of whether he (the opponent) was in the same zone at the time the puck was passed or not (no "slow whistle").
- (g) If the Linesman shall have erred in calling an off-side pass infraction (regardless of whether either team is shorthanded), the puck shall be faced on the center ice face-off spot.

Rule 628. Puck Out of Bounds or Unplayable

- (a) When the puck goes outside the playing area or strikes any obstacles above the playing surface other than the boards, glass or wire, or deflects off an Official out of the playing area, it shall be faced-off from where it was shot or deflected by a player, unless otherwise expressly provided in these rules.

If the puck leaves the playing area or becomes unplayable due to a defect in the playing rink, a face-off will take place at the point where the puck was last played.

- (b) When the puck becomes lodged in the netting on the outside of either goal so as to make it unplayable, or if it is frozen between opposing players intentionally or otherwise, the Referee shall stop the play and face-off the puck at either of the adjacent face-off spots unless in the opinion of the Referee the stoppage was caused by a player of the attacking team, in which case the resulting face-off shall be conducted in the Neutral Zone.

(Note) This includes a stoppage of play caused by a player of the attacking team shooting the puck onto the back of the defending team's goal without any intervening action by the defending team.

The defending team and/or the attacking team may play the puck off the net at any time. However, should the puck remain on the net for longer than three seconds, play shall be stopped and the face-off shall take place on an end zone face-off spot except when the stoppage is caused by the attacking team, in which case the face-off shall take place on a face-off spot in the Neutral Zone. However, if the puck comes to rest on top of the goal frame or in the netting on top of the goal frame, play shall be stopped immediately.

- (c) A minor penalty shall be imposed on a goalkeeper who deliberately drops the puck on the goal netting to cause a stoppage of play.
- (d) If the puck comes to rest on top of the boards surrounding the playing area, it shall be considered to be in play and may be played legally by the hand or stick.

Rule 629. Puck Must Be Kept In Motion

- (a) The puck must at all times be kept in motion. Play shall not be stopped because the puck is frozen along the boards by two more opposing players, unless a player falls on or is knocked down onto the puck. If one player freezes the puck along the boards or if a player deliberately falls on the puck a minor penalty for delaying the game shall be assessed under Rule 609(e) or Rule 612(a).

(Note) Notwithstanding the above, the Referee may stop play along the boards if in his judgment allowing play to continue will lead to unnecessary contact surrounding the puck.

- (b) A minor penalty shall be imposed on any player including the goalkeeper who holds, freezes or plays the puck with his stick, skates or body along the boards in such a manner as to cause a stoppage of play.
- (c) A player beyond his Defending Zone shall not pass nor carry the puck backward into his Defending Zone for the purpose of delaying the game except when his team is below the on-ice numerical strength of the opponents. For an infringement of this rule, the face-off shall be at the nearest end face-off spot in the Defending Zone of the offending team.

Rule 630. Puck Out of Sight and Illegal Puck

- (a) Should a scramble take place, or a player accidentally falls on the puck, and the puck is out of sight of the Referee, he shall immediately blow his whistle and stop the play. The puck shall then be “faced-off” at the point where the play was stopped, unless otherwise provided for in the rules.
- (b) If, at any time while play is in progress, a puck other than the one officially in play shall appear on the playing surface, which interferes with the progress of the game, the play shall be stopped immediately.

Rule 631. Puck Striking Official

- (a) Play shall not be stopped because the puck touches an Official anywhere on the rink.

Rule 632. Refusing to Start Play

- (a) If, when both teams are on the ice, one team for any reason shall refuse to play when ordered to do so by the Referee, he shall warn the Captain and allow the team so refusing fifteen seconds within which time to begin the game or resume play. If at the end of that time the team shall still refuse to play, the Referee shall impose a bench minor penalty on the offending team, and the case shall be reported to the proper authorities for further action. Should there be a recurrence of the same incident, the Referee shall have no alternative but to suspend the game and impose a gross misconduct penalty on the offending Team Official(s) responsible for the incident.
- (b) If a team, when ordered to do so by an On-Ice Official, through a Team Official, fails to go onto the ice promptly, it shall receive a bench minor penalty. If the team fails to go onto the ice and start play within five minutes, the game shall be suspended and the offending Team Official(s) shall be assessed a gross misconduct penalty.

(Note) The local governing body or Disciplinary Committee shall determine whether the suspended game shall be deemed completed, forfeited, resumed from the point of suspension or canceled and shall issue instructions pertaining to records, etc.

Any team refusing to start play may be subject to a fine not to exceed one thousand dollars (\$1,000) plus financial losses incurred by the non-offending team.

Rule 633. Slashing

- (a) A minor or a major penalty shall be imposed on any player who slashes or attempts to slash an opponent with his stick.
- (b) A major plus game ejection penalty or a major plus game misconduct penalty shall be imposed on any player who injures an opponent by slashing.

(Note) Referees should penalize as “slashing” any player who swings his stick at any opposing player (whether in or out of range) without actually striking him or where a player on the pretext of playing the puck makes a wild swing at the puck with the object of intimidating an opponent.

- (c) Any player who swings his stick at another player in the course of any altercation shall be subject to a game misconduct or a match penalty.

(Note) The Referee shall impose the normal appropriate penalty provided in the other sections of this rule and shall, in addition, report to the proper authorities.

- (d) A minor penalty shall be imposed on any player who makes stick contact with an opposing goalkeeper while he is in his goal crease, who has covered or caught the puck, regardless of whether or not the Referee has stopped play.

Rule 634. Spearing

- (a) A minor plus misconduct penalty or a double minor plus game ejection penalty or a major plus game misconduct penalty shall be imposed on a player who spears or attempts to spear an opponent. The minor plus misconduct penalty option may only be assessed for an attempted spear where no contact with the opponent is made.

(Note 1) “Spearing” shall mean poking an opponent with the point of the stick blade while the stick is being carried with one hand or both hands.

(Note 2) “Attempt to spear” shall include all cases where a spearing gesture is made regardless of whether or not bodily contact is made.

(Note 3) Spearing may also be treated as Attempt to Injure or Deliberate Injury of Opponents under Rule 603.

Rule 635. Start of Game and Periods

- (a) The game shall be commenced at the time scheduled by a “face-off” at the center ice face-off spot and shall be renewed promptly at the conclusion of each intermission in the same manner.

No delay shall be permitted by reason of any ceremony, exhibition, demonstration or presentation unless consented to reasonably in advance by the visiting team.

- (b) Home teams shall have the choice of goals to defend at the start of the game except where both players' benches are on the same side of the rink, in which case the home team shall start the game defending the goal nearest its own bench. The teams shall change ends for each succeeding regular period.

If in the opinion of the Referee, conditions are more favorable to play at one end of the rink than the other, the Referee may equalize opportunities by having the teams change ends at the middle of one or all three regular and overtime periods, but not in only two regular periods. The Referee shall declare before the commencement of the game or period that this change is to be made, and the change shall take place at the exact midpoint of a period and not at a stoppage of play nearest that point.

- (c) In order to standardize the player introduction practice throughout Junior hockey, the following shall apply. After the Referee has blown his whistle announcing the commencement of the introductions, all non-starters shall remove themselves from the ice promptly. The starting line-ups shall assemble on their respective goal lines, and shall be individually introduced, at which time each player, as his name is called, shall skate to his respective blue line and remain at that line during the remainder of the introductions. During the entire player introduction process, all players shall stand facing center ice. Failure to comply with this requirement may result in a fine of up to one hundred dollars (\$100) per player per occurrence. The Officials shall stand at an appropriate position on the center red line immediately following the introductions, after which the national anthem(s) shall be played. Following the completion of the national anthem(s), the game shall be promptly commenced.

- (d) During the pre-game warm-up (not less than 12 and no more than 15 minutes - recommended time is 15 minutes) and before the commencement of play in any period, each team shall confine its activity to its own half of the rink. Any player crossing the center red line during warm-ups, or any player who shoots a puck at an opponent or in direction of the opponent's goal, before the game and between periods will receive a minor penalty. The Referee is instructed to strictly enforce this rule. (See Rule 613(h).)
- (e) Fifteen minutes before the time scheduled for the start of the game, both teams shall vacate the ice and proceed to their dressing rooms while the ice is being flooded. Both teams shall be signaled by the Game Timekeeper to return to the ice together in time for the scheduled start of the game or period. It is recommended that, when both teams are to leave the ice through a common exit, the team whose players' bench is closer to the exit leave first. The home team should enter the ice surface first.
- (Note) In order to speed up the start of a game, all players are required to promptly leave the ice surface at the conclusion of warm-ups and at the end of each period. A failure to exit one minute after the conclusion of a period or warm-up shall result in the following:*
1. *First Offense - Written warning from the League.*
 2. *Second Offense - A fine not to exceed twenty five dollars (\$25) per occurrence per player to the team.*
- (f) At the end of the first and second periods, and the third period should the game be tied, all players that must come onto the ice to reach their dressing rooms must remain on the bench until the Referee gives them a signal to leave. Should both teams have to leave by way of the ice, the Referee will direct the visiting team to leave the bench first, then the home team may leave upon the Referee's signal. The home team may exit first if this prevents the teams from crossing, upon instructions to do so by the Referee. Failure to wait for the Referee's signal will result in a minor penalty to either or both teams. At the end of the game the Referee will determine when the players have separated sufficiently to prevent any possible situations and at that time will give both teams a signal that they may leave their benches to meet their goalkeeper prior to going to their rooms. Failure to wait for this signal or any situations caused after the teams have left their benches will be reported to the League for review.
- (g) At the beginning of the second and third periods and overtime periods in play-offs (0:00 on the clock), teams must be on the ice or be observed to be proceeding to the ice. For failure to comply, a bench minor penalty for delay of game shall be imposed.
- (h) Should a game be delayed by two and one-half hours at the start of the game or by two hours during the actual playing time, because of conditions beyond control (i.e., bus problems, road conditions, playing conditions, etc.), the Referee shall have the authority to suspend the game after conferring with both teams. The circumstances surrounding the incident shall be immediately reported to the League. It is recommended that a Junior game not start after 9:45 p.m.
- (i) A Coach and/or Team Official shall have the responsibility to be on the players' bench during all times when players from that team are on the ice, including but not limited to pre-game warm-up during each period, and at the conclusion of the period/game, until both teams have cleared the ice, unless removed by the Referee or Discipline Committee action.
- (j) There shall be no handshake at the end of any regular season or play-off game until the play-off series has been concluded.

Rule 636. Throwing Stick

- (a) When any player or Team Official of the defending team deliberately throws or shoots a stick or any part thereof or any other object at the puck in his Defending Zone, the Referee shall allow the play to be completed and if a goal is not scored, a penalty shot/optional minor shall be taken by the player designated by the Referee as the player fouled.

If, however, the goal being unattended and the attacking player having no defending player to pass and having a chance to score on an "open goal," a stick or part thereof or any other object is thrown or shot by any member of the defending team in or into its Defending Zone, thereby preventing an obvious and imminent goal, a goal shall be awarded to the attacking team.

(Note 1) If the Officials are unable to determine the person against whom the offense was made, the non-offending team, through the Captain, shall designate a player on the ice at the time the offense was committed to take the shot.

(Note 2) For the purpose of this rule, and open goal is defined as one from which a goalkeeper has been removed for an additional attacking player.

- (b) A minor penalty shall be imposed on any player on the ice who throws his stick or any part thereof or any other object in the direction of the puck in any zone, except when such act has been penalized by a penalty shot or the awarding of a goal.

(Note) When a player discards the broken portion of a stick by tossing it to the side of the rink (and not over the boards) in such a way as will not interfere with play or an opposing player, no penalty shall be imposed for so doing.

- (c) A misconduct penalty shall be imposed on any player or goalkeeper who throws a stick or any part thereof outside the playing area.

If the offense is committed in protest of an Official's decision, a game misconduct penalty shall be assessed the offending player.

A game misconduct penalty shall be imposed on any player or goalkeeper who deliberately throws a stick or any part thereof outside the playing area at or in the direction of any spectators.

Rule 637. Time of Match or Time-Outs

- (a) The maximum time allowed for a game shall be three 20 periods of actual play with a rest intermission between periods.

Play shall be resumed promptly following each intermission upon the expiration of 15 minutes from the completion of play in the preceding period. A preliminary warning shall be given by the Game Timekeeper to the Officials and to both teams 3 minutes prior to the resumption of play in each period and the final warning shall be given in sufficient time to enable the teams to resume play promptly.

(Note) For the purpose of keeping the spectators informed as to the time remaining during intermissions, the Game Timekeeper will use the electric clock to record length of intermissions.

- (b) The team scoring the greater number of goals during the three periods shall be the winner, and shall be credited with two points in the standings.
- (c) In the intervals between periods, the ice surface shall be flooded unless mutually agreed to the contrary.
- (d) If any unusual delay occurs in the first or second periods, the Referee may order the next regular intermission to be taken immediately and the balance of the period will be completed on the resumption of play with the teams defending the same goals, after which the teams will change ends and resume play of the ensuing period without delay.
- (e) Each team shall be permitted to take one time-out of a one minute duration during the game, which must be taken during a stoppage of play. If one team takes a time-out, the opposing team may exercise the rights of a time-out, including warming up a goalkeeper. Non-penalized players and goalkeepers may proceed to their respective team bench during any time-out.

When the time-out is used to warm up goalkeeper(s), no more than four (4) pucks per team shall be allowed on the ice.

- (f) If, in the opinion of the Referee, playing conditions beyond the control of the Officials and game participants (such as ice conditions, broken glass or weather) become unsatisfactory during the course of the game, the game may be suspended.

Rule 638. Tied Games

- (a) Any overtime period shall be considered part of the game and all unexpired penalties shall remain in force.
- (b) If either team declines to play in the necessary overtime period or periods, the game shall be declared a loss for that team.
- (c) During play-offs and National Championships, if at the end of three periods the score is tied, the following shall take place:
 1. Teams shall return to their dressing room and the ice shall be resurfaced.
 2. Teams shall change ends.

3. A twenty-minute period shall be played.
4. The game shall terminate upon a goal being scored and the team scoring declared the winner. If no goal is scored, the same procedure as above shall be repeated until a winner has been determined.

(Note) Each League may make its own procedure regarding overtime during exhibition and regular season games.

Rule 639. Tripping

- (a) A minor or major penalty shall be imposed on any player who shall place his stick, foot, arm, hand, elbow or extends his leg (Leg Checking), from in front or from behind, in such a manner that it shall cause his opponent to trip or fall.

(Note 1) If, in the opinion of the Referee, a player is unquestionably hook-checking the puck and obtains possession of it, thereby tripping the puck carrier, no penalty shall be imposed.

(Note 2) Accidental trips which occur simultaneously with or after a stoppage of play will not be penalized. Any player who deliberately leaves his feet and contacts an opponent with any part of his body thereby causing the opponent to trip or fall shall be assessed a minor penalty (Clipping).

(Note 3) This rule does not apply to a player who has dropped to his knee(s) to block a shot.

- (b) A major plus game ejection penalty or a major plus game misconduct penalty shall be imposed on any player who injures an opponent as a result of a foul committed by tripping or leg checking.
- (c) When a player, in control of the puck on the opponent's side of the center red line and having no other opponent to pass than the goalkeeper, is tripped or otherwise fouled from behind, thus preventing a reasonable scoring opportunity, a penalty shot/optional minor shall be awarded to the non-offending team. Nevertheless, the Referee shall not stop the play until the attacking team has lost possession and control of the puck to the defending team.

(Note) The intention of this rule is to restore a reasonable scoring opportunity which has been lost by reason of a foul from behind when the foul is committed on the opponent's side of the center red line.

“Possession and control of the puck” (See Glossary) means the act of propelling the puck with a stick. If, while it is being propelled, the puck is touched by another player or his equipment or hits the goal or goes free, the player shall no longer be considered to be “in possession and control of the puck.”

- (d) If, when the opposing goalkeeper has been removed from the ice, a player in control of the puck on the attacking side of the center red line is tripped or otherwise fouled with no opposition between him and the opposing goal, thus preventing an obvious and imminent scoring opportunity, the Referee shall immediately stop the play and award a goal to the attacking team.

Rule 640. Unnecessary Roughness (Roughing)

- (a) At the discretion of the Referee, a minor or double minor penalty may be imposed on any player deemed guilty of unnecessary roughness. Any action worthy of a major penalty under this sub-section must be assessed under Rule 613 (Fisticuffs).
- (b) A minor or a major penalty, at the discretion of the Referee, shall be imposed on a player who makes physical contact with an opponent after the whistle has been blown if, in the opinion of the Referee, the player has had sufficient time after the whistle to avoid such contact. If the opponent is injured from this check, a major plus game ejection penalty or a major plus game misconduct penalty shall be assessed.



APPENDICES
SUMMARY OF PENALTIES
SUMMARY OF FACE-OFF LOCATIONS

SUMMARY OF PENALTIES

The following summary of penalties is intended for general application of the rules. Specific situations may require different applications. All referenced rules should be consulted for exact language.

MINOR PENALTY

Personal Fouls

- 601(a) Unsportsmanlike Conduct
- 601(b) Shooting puck after whistle
- 618(a) Holding
- 621(a) Interference
- 611(d) Face-off interference
- 621(b) Interference by player on bench
- 621(c) Interfering with goalkeeper in crease
- 625(d) Leaving penalty bench prematurely
- 633(d) Stick contact with goalkeeper
- 635(d) Pre-game skating across center line
- 639(a) Leaving feet and contacting opponent

Delay of Game, player or goalkeeper

- 602(a,c) Adjusting clothing/equipment
- 609(a) Batting/shooting puck out of rink
- 609(b) Throwing puck out of rink
- 609(c) Deliberate goal displacement
- 609(e) Freezing puck along boards or net
- 609(f) Continued improper face-off position
- 609(g) Delaying face-off
- 611(b) Second face-off violation, same team
- 612(a,b) Falling on puck
- 615(d) Picking up puck from ice
- 629(a,b) Freezing puck along boards

Goalkeeper Infractions

- 303(d) Wearing illegal equipment
- 406(b) Thrown stick during penalty shot
- 407(d) Leaving crease area during altercation
- 407(e) Participating in play across center line
- 605(c) Going to bench for stick at stoppage
- 615(a) Holding puck more than 3 seconds
- 615(b) Piling up obstacles in front of goal
- 628(c) Dropping puck onto goal netting

Stick and Equipment Violations

- 301(d) Playing with an illegal stick
- 301(d) Player playing with goalkeeper stick
- 301(f) Playing with more than one stick
- 304(a) Equipment not worn under uniform
- 605(a) Playing with a broken stick
- 605(b) Receiving a stick illegally
- 613(f) Dropping glove(s)/stick in altercation
- 636(b) Throwing a stick (non-Penalty Shot)

Bench Minor Penalty

- 104(e) Goalkeeper warm-up area violation
- 109(c) Alcohol, tobacco, smoking on bench
- 204(d) Starting lineup violation
- 205(a) Too many players on the ice
- 205(d,f) Illegal entry from penalty bench
- 205(e,f) Goalkeeper to bench at stoppage
- 206(d) Injured/penalized player returns prematurely
- 301(d) Stick measurement legal
- 304(c) Mouthpiece challenge not sustained
- 307(c) Equipment measurement (legal)
- 601(c1,h2) Obscene, profane, abusive language on players' bench
- 601(c2,h3) Article thrown onto ice from players' bench
- 601(h1) Team Official bangs boards
- 601(h4) Team Official inciting opponent
- 601(h5) Non-physical interference with Game Official from players' bench
- 609(d) Continued incorrect players on ice
- 632(a) Refusing to start play
- 632(b) Refusing to go on ice
- 635(f,g) Delay during intermission

Minor or Double Minor Penalty

- 640(a) Unnecessary roughness

Minor or Major Penalty

- 604(a,b) Boarding
- 606(a,b) Charging
- 608(a,b) Cross-Checking
- 610(a,b) Elbowing/Kneeing
- 619(a,b) Hooking
- 633(a,b) Slashing
- 639(a) Tripping/Leg Checking
- 640(b) Checking opponent after whistle

Required penalty if resulting in injury:

Major plus Game Ejection or Game Misconduct

Minor, or Major plus Game Ejection, or Major plus Game Misconduct

- 604(c) Boarding in Icing situation
- 618(b) Grabbing facemask

Minor, Minor plus Misconduct, Double Minor plus Game Ejection, or Major plus Game Misconduct

- 607(a,b,c) Checking from behind
(Major plus Game Misconduct required if injury results)

Minor, Double Minor, Major, Major plus Game Ejection, or Major plus Game Misconduct

- 617(a,b) High-sticking
If injury results, options are:
if accidental Double Minor, or
if careless Major plus Game Misconduct or Major plus Game Ejection

Double Minor plus Game Ejection, or Major plus Game Misconduct

- 603(d) Head-butting
(Major plus Game Misconduct required if injury results)

Minor plus Misconduct or Double Minor plus Game Ejection, or Major plus Game Misconduct

- 608(c) Butt-ending
- 634(a) Spearing
(Major plus Game Misconduct required if injury results)

Major, or Minor plus Game Ejection, or Minor plus Game Misconduct

- 613(a) Fisticuffs (origination)

Minor, Double Minor, Major, Major plus Misconduct, or Major plus Game Ejection, or Major plus Game Misconduct

- 613(b,c,e) Fisticuffs (retaliation)

Minor plus Misconduct Penalty

- 301(e) Not surrendering stick for measurement

Minor plus Game Misconduct Penalty

- 613(f) Drop glove(s)/stick and instigate altercation

Major plus Game Ejection, or Major plus Game Misconduct

- 613(g) Major following original altercation

Major plus Game Misconduct

- 625(b) Leaving bench in altercation (max. 5 players per team)

Bench Minor or Game Misconduct, or both

- 625(h) Team Official on ice without permission

Major plus Game Misconduct or Match

- 623(a,b) Kicking opponent

Match Penalty

- 603(a) Attempt to injure opponent
- 603(a) Deliberate injury of opponent
- 603(c) Taped hand, cutting opponent in altercation

Misconduct Penalty

- 304(b) Helmet/facemask not worn on bench
- 304(c) Mouthpiece violation
- 304(e) Protective equipment violation
- 305(b) Playing with cut palm on glove
- 406(f) Distraction during penalty shot
- 601(a) Persisting in unsportsmanlike conduct
- 601(d1) Obscene, profane, abusive language (player)
- 601(d2) Puck shot away from Official retrieving it
- 601(d3) Throwing equipment out of rink
- 601(d4) Not proceeding to penalty bench or dressing room when so ordered
- 601(d5) Player in Referee's crease
- 601(d6) Non-physical Interference with Game Official
- 609(g) Delaying face-off

Misconduct or Game Ejection or Game Misconduct Penalty

- 601(a) Persisting in unsportsmanlike conduct
- 601(e1) Touching or holding Game Official
- 601(e2) Continuing altercation after warning
- 601(e3) Banging boards or glass with stick (player)
- 636(c) Stick thrown out of playing area

Game Ejection Penalty

613(d) First to intervene in an altercation

Game Ejection or Game Misconduct Penalty

613(g) Fisticuffs during line change

613(j) Removing equipment in an altercation

Game Ejection or Game Misconduct Penalty plus fine up to \$750

601(i1) Obscene gesture

601(i1) Racial/ethnic slur

601(i2) Persisting Team Official conduct, after Bench Minor

601(i3) Physically interfering with a Game Official

601(i4) Threatens harm or injury

Game Misconduct Penalty

403(b) Second major penalty in same game

601(f2) Obscene gesture (player)

601(f1) Persisting player conduct, after Misconduct

601(f2) Racial/ethnic slur

622(b) Player interference with spectator

Game Misconduct or Match Penalty

633(c) Swinging stick at opponent in altercation

Gross Misconduct Penalty

601(g1,j1) Injury or attempting to injure Game Official

601(g2,j2) Injury or attempting to injure opponent (except player to player)

601(g3,j3) Detrimental behavior

603(b) Attempt to injure non-player

603(b) Deliberate injury to non-player

632(a,b) Refusal to start play (game suspended)
For violations under sub-section (j), a fine up to \$1,000 may be assessed**Gross Misconduct II Penalty**

601(g1,j1) Injuring Game Official

601(g2) Injuring opposing Team Official

601(j2) Injuring opponent
For violations under sub-section (j), a fine up to \$2,000 may be assessed**Penalty Shot/Optional Minor (only)**

205(c) Deliberate illegal substitution

609(c) Goalkeeper deliberately displaces goal, no break-away

609(c) Deliberate removal of goalkeeper's helmet/facemask, break-away

621(f) Thrown stick from bench, break-away

625(g) Illegal entry from bench, break-away

Penalty Shot/Optional Minor or Awarded Goal

609(c) Deliberate goal displacement in scoring opportunity

612(c) Player falling on puck in crease

615(d) Player picking up puck from crease

636(a) Stick thrown at puck in Defending Zone

639(c,d) Fouled from behind on break-away

Awarded Goal (only)

609(c) Deliberate goal displacement preventing a goal

615(b) Goalkeeper stick left in front of goal, preventing a goal

Fines

	Max.	
105(d)	\$200.	Non-approved ice markings
111(c)	\$200.	Signal lights not operational
112(a)	\$2000.	Inadequate protection
201(b)	\$1000.	Failure to register coaches
202(a)	\$25.	Captain/Alternate violation
203(c)	\$50.	Player uniform violation
303(b)	\$500.	Goalkeeper equipment measure
404(d)	\$100.	Buying suspension (+\$50. filing)
404(g)	\$500.	Unserved suspension
410(b)	\$100.	Buying suspension
501(a)	\$50.	Not providing Off-Ice Officials
601(i)	\$750.	Team Official getting Game Misc./Game ejection
601(j)	\$1500.	Gross Misconduct I
601(j)	\$2500.	Gross Misconduct II
613(f)	\$100.	Not going to bench-altercation
613(f)	\$25.	Player not going to bench-altercation
613(h)	\$2000.	Altercation not during periods
625(b)	\$1000.	Leaving bench (alterc.)-Team
625(b)	\$250.	Leaving bench (alterc.)-Player
625(h)	\$3000.	Team official on ice
625(k)	\$1000.	Players leaving bench
632(b)	\$1000.	Refusing to start play
635(c)	\$100.	Introduction violation
635(e)	\$25.	Player not leaving ice/end periods

SUMMARY OF FACE-OFF LOCATIONS

Center Ice Spot

- 635(a) Start of game and periods
- 611(i) Goal scored
- 205(b) Premature goalkeeper substitution (normal)
- 627(g) Offside pass error by officials

Neutral Zone Spot

- 409(b) Coincident icing and delayed penalty
- 611(f) Stoppage by attacking player in Attacking Zone
- 611(f) Attacking player shoots puck onto netting
- 611(k) Gathering of players
- 621(d) Goal crease violation
- 626(b) Puck carried off-side
- 626(g) Off-side error by officials
- 628(b) Attacking team makes puck unplayable

End Zone Face-Off Spot

- 304(a) Playing without a helmet
- 406(g) Unsuccessful penalty shot attempt
- 611(h) Last play face-off between end spots and end boards
- 611(i) Goal illegally scored off official
- 615(c) Goalkeeper throws puck forward
- 617(d) High-sticked puck
- 620(a) Icing
- 620(f) Icing error by officials
- 626(f) Intentional off-side
- 628(b) Defending player shoots puck onto netting
- 629(c) Bringing puck back into Defending Zone

Last Play Face-Off

- 611(g) General rule
- 205(b) Premature goalkeeper substitution (exception)
- 409(a) Penalty on team in possession
- 409(b) Stoppage following delayed penalty signal
- 611(g) Fouls by players on both sides simultaneously
- 615(e) Hand pass
- 622(a,c) Interference by spectators
- 626(b) Puck passed off-side
- 627(a) Center line off-side pass
- 628(a) Puck strikes overhead obstruction/rink defect
- 629(a) Stalled puck between opposing players
- 630(a) Puck out of sight of Referee



USA HOCKEY, INC.
1775 Bob Johnson Drive
Colorado Springs, CO 80906
(719) 576-USAH
www.usahockey.com